

de	Gebrauchsanweisung	2
en	User's Manual	12
fr	Mode d'emploi	22
it	Istruzioni per l'uso	32
es	Instrucciones de empleo	42
pt	Manual de operação	52
ru	Руководство по применению	62



KaWe MASTERLIGHT HL / LED



QM-1-045U





Gebrauchsanweisung Praxisleuchte KaWe MASTERLIGHT HL / LED

Inhaltsverzeichnis

1. Sicherheitshinweise	Seite 2
2. Kurzbeschreibung der Leuchte KaWe MASTERLIGHT HL / LED	Seite 3
3. Lieferumfang	Seite 3
3.1 Montageanleitung: 5-Fuß-Stativ	Seite 4
3.2 Montageanleitung: Tischbefestigung	Seite 5
3.3 Montageanleitung: Wandbefestigung	Seite 7
3.4 Leuchtmittel austauschen	Seite 7
4. Reinigung	Seite 7
4.1 Stativ	Seite 7
4.2 Leuchtenkörper	Seite 7
4.3 Praxisleuchte	Seite 7
5. Technische Daten	Seite 7
6. Wartung	Seite 7
6.1 Regelmäßige Wartungsarbeiten	Seite 7
7. Hinweise zur elektrischen Installation	Seite 8
7.1 Umgebungsbedingungen	Seite 8
7.2 Wichtige Hinweise	Seite 8
8. Basis UDI-DI	Seite 8
9. Entsorgung	Seite 8
10. Tabellen:	
Hinweis zu elektronischer Verträglichkeit	Seite 9
11. Gewährleistung	Seite 11

Sehr geehrter Kunde, vielen Dank dass Sie sich für ein KaWe Produkt entschieden haben. Unsere Produkte zeichnen sich durch eine hohe Qualität und Langlebigkeit aus. Die Leuchten erfüllen die Bestimmungen der Verordnung (EU) 2017/745 (europäische Medizinprodukte-Verordnung) und gehören gemäß dieser Verordnung zur Medizinproduktklasse I.

 **Bitte lesen Sie diese Gebrauchsanleitung vor der Benutzung sorgfältig und vollständig durch und beachten Sie die Sicherheitshinweise.**

Die Vorteile der LED-Technik: Eine Lebensdauer von mindestens 50.000 Stunden, hohe Helligkeit und eine kaum wahrzunehmende Wärmeentwicklung, sowohl im Kopfbereich des Chirurgen als auch im Wundfeld. Die Vorteile der bisherigen von KaWe eingesetzten Lichttechnik mit Halogenlampen wurden beibehalten: natürliche Farbwidergabe, exaktes Ausleuchten des Wundfeldes und leichte Positionierung des Leuchtenkörpers.

► 1. SICHERHEITSHINWEISE

Zur Handhabung der Leuchte muss die Gebrauchsanleitung beachtet werden.

ACHTUNG: Dieses Gerät ist nicht für den Betrieb in explosionsgefährdeten Bereichen bestimmt.

Bitte lesen Sie die Gebrauchsanleitung sorgfältig durch, um alle Vorzüge Ihres Leuchtensystems nutzen zu können und um eventuelle Schäden am Gerät zu vermeiden.

Die Instandsetzung der Leuchte und besonders Montagearbeiten dürfen nur durch Fachpersonal erfolgen.

Die Sicherheit der Leuchte wird vom Hersteller nur dann verantwortet, wenn Reparaturen und Änderungen von ihm selbst oder einer die Einhaltung der Sicherheitsregeln garantierenden Stelle vorgenommen wird.

ACHTUNG: Eine Veränderung an der Leuchte ist nicht erlaubt!

Keine Haftung des Herstellers bei Personen- oder Sachschäden, wenn die Leuchte zweckentfremdet oder falsch bedient oder eingesetzt wird. Die KaWe MASTERLIGHT HL / LED ist mit anderen Geräten nicht kombinierbar.

Vergewissern Sie sich vor jedem Gebrauch davon, dass sich die Leuchte in einwandfreiem Zustand befindet.

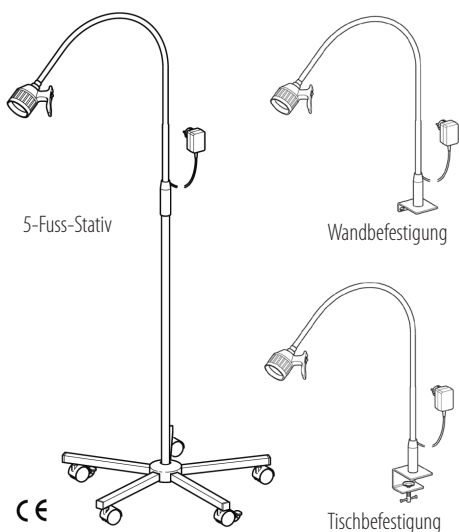

Allgemeine Hinweise

- Alle KaWe Stativ-Leuchten werden mit sämtlichen für Montage und Anschluss erforderlichen Teilen ausgeliefert.
- Die Befestigung erfolgt am Stativ, an der Wand oder am Tisch.
- Aus Gründen der Verpackung wird der Fünffuß des Stativs zerlegt geliefert. Das Stativrohr ist immer als Einheit zusammengebaut und muss nur noch mit seiner unteren Befestigungsschraube am Fuß angebracht werden.
- Die Leuchte wird mit integriertem Anschlusskabel und Schutzkontaktstecker geliefert.
- Die verwendete Steckdose muss den Anforderungen von IEC bzw. VDE 0100-710 gemäß installiert sein.

Erklärung der Symbole:

	Hersteller
	Herstellungsdatum
	Chargencode
	Gebrauchsanweisung beachten
	Achtung!
	Temperaturbegrenzung
	Getrennte Sammlung von Elektro- und Elektronikgeräten
	CE Konformitätszeichen
	Medizinprodukt
	GOST-R Zertifizierung von Exportwaren nach Russland
	Luftfeuchtebegrenzung
	Gerät der Schutzklasse II
	Zerbrechlich
	Vor Nässe schützen
	Warnung vor elektromagnetischem Feld

2. KURZBESCHREIBUNG DER LEUCHE KaWe MASTERLIGHT HL / LED

Zweckbestimmung:

Die Leuchten sind zur Unterstützung von Behandlung & Diagnose im Krankenhaus oder in einer Arztpraxis vorgesehen. Sie beleuchten das Arbeitsfeld und den Körper des Patienten mit einem schattenfreien, „kalten“ Hochleistungslicht.

Anwendung:

Dieses Produkt darf nur durch autorisiertes Fachpersonal angewendet werden!

Vorgesehene Patientengruppe:

Alle Patientengruppen

3. LIEFERUMFANG

- 1x Montageblock Stativ
- 2x Fußrohre mit Bremsrollen
- 3x Fußrohre ohne Bremsrollen
- 1x Stativrohr
- 1x Stativkappe
- 1x Zylinderschraube M8 mit Scheibe
- 1x Gabelschlüssel
- Leuchtenkörper mit Arm
- Gebrauchsanweisung

Hinweis an Anwender & Patienten:

Alle in Zusammenhang mit dem Produkt auftretenden schwerwiegenden Vorfälle sind unverzüglich dem Hersteller und der zuständigen Behörde des jeweiligen Mitgliedsstaats, in dem der Anwender und/oder Patient niedergelassen ist zu melden.

3.1 Montageanleitung: 5-Fuss-Stativ

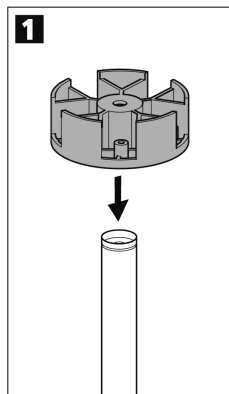
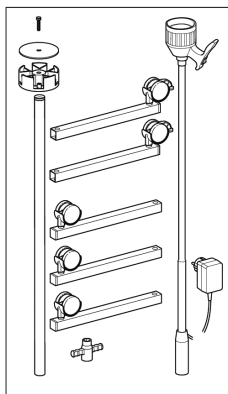
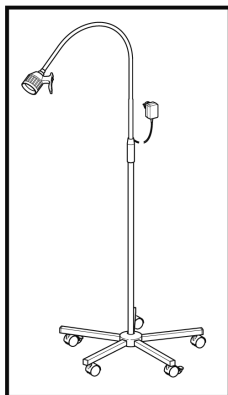

Montageteile

1. Block aufstecken.

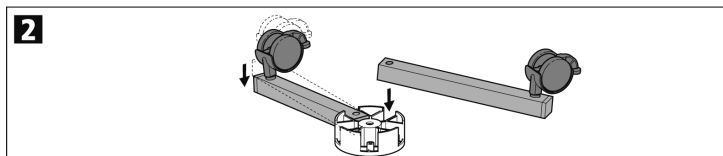

2. Zwei Fußrohre mit Bremsrollen gegenüber einhängen.

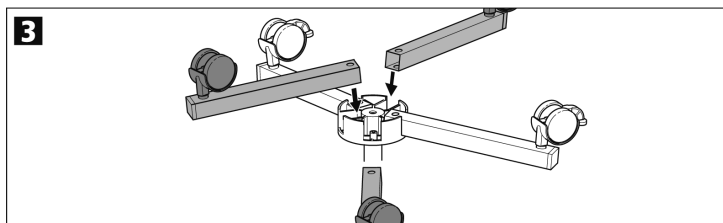

3. Drei Fußrohre ohne Bremsrollen einhängen.

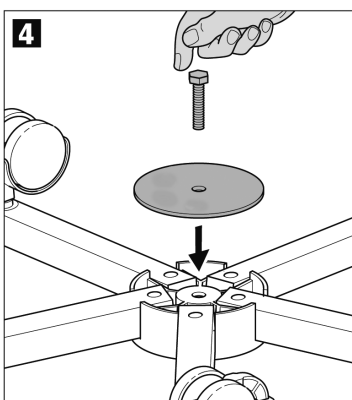

4. Sechskantschraube eindrehen.

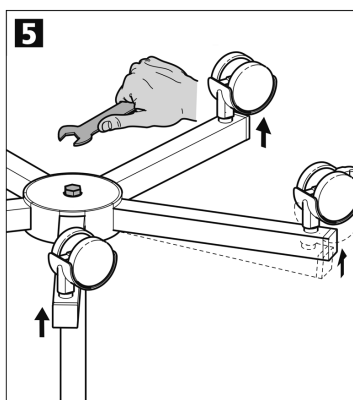

5. Sechskantschraube anziehen.

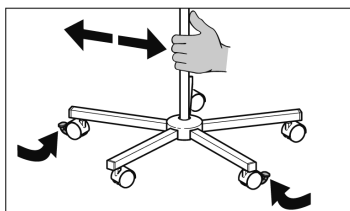
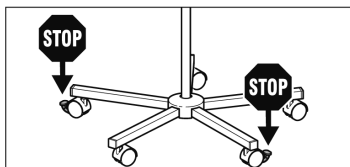
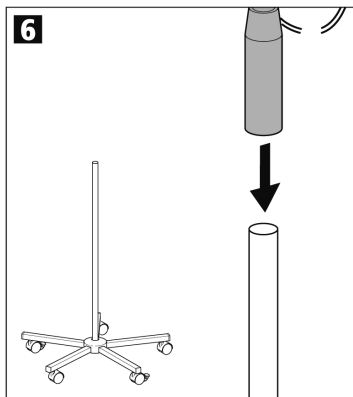

6. Praxisleuchte-Oberteil auf Fußteil schieben.

Bremsrollen arretieren.
Zur Fortbewegung
Bremsrollen lösen.

3.2 Montageanleitung: Tischbefestigung

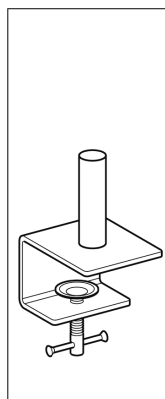
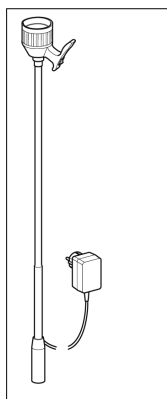
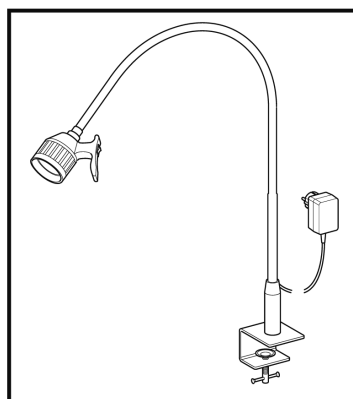

Montageteile

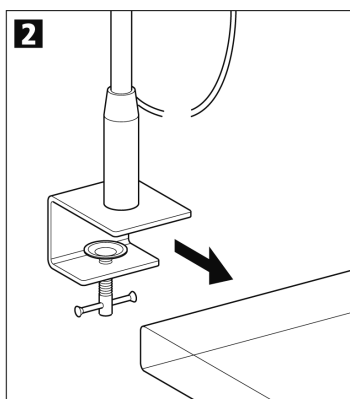
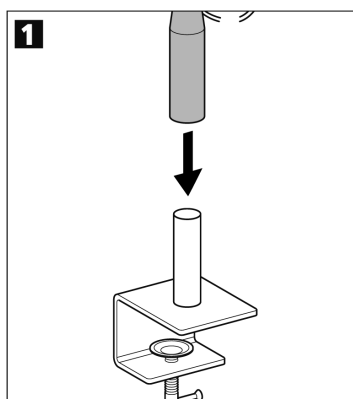

1. Praxisleuchte-Oberteil auf Tischklemme schieben.

2. Praxisleuchte an Tischplatte schrauben.

3.3 Montageanleitung: Wandbefestigung

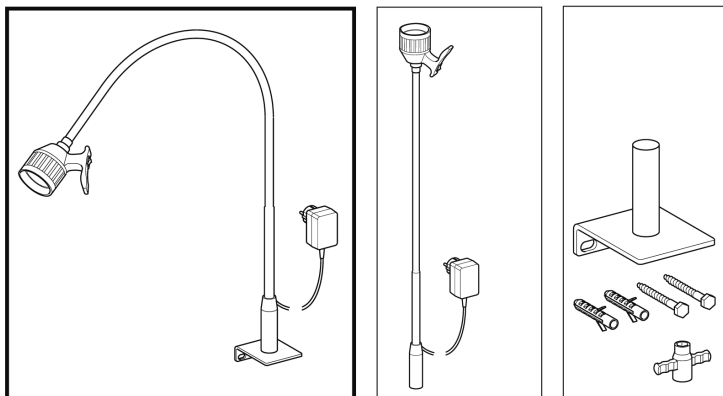

Montageteile

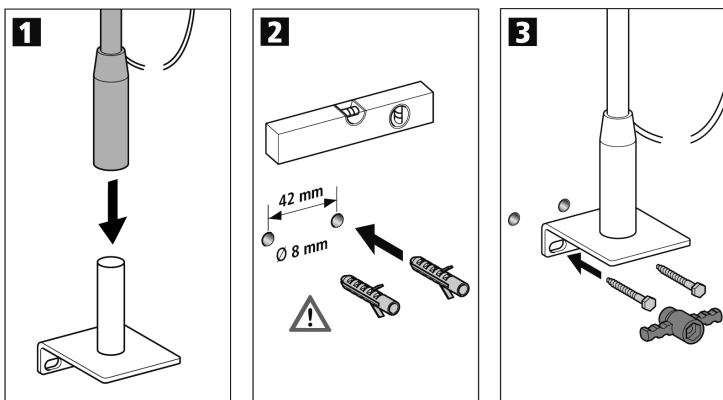

1. Praxisleuchte-Oberteil auf Wandhaltewinkel schieben



2. Vorsicht beim Bohren! Wand auf Strom-, Gas- und Wasserleitungen überprüfen.

3. Praxisleuchte an die Wand schrauben.

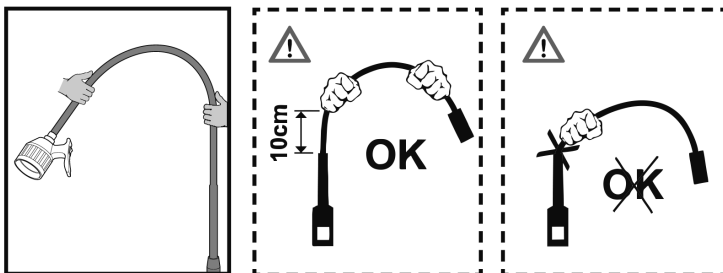

Lichtrichtung nur mit beiden Händen einstellen.

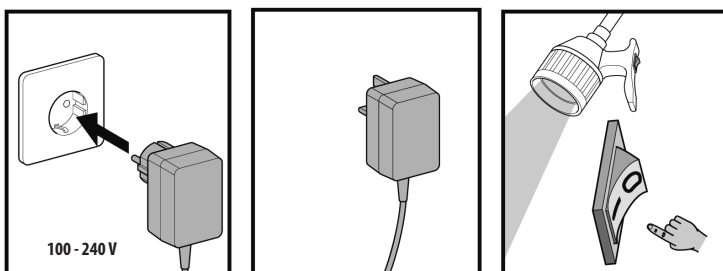

Netzanschluss (EU / GB)

EIN-schalten - I -
AUS-schalten - O -

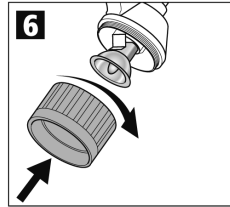
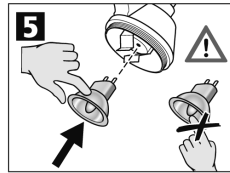
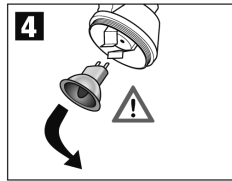
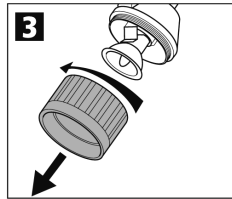
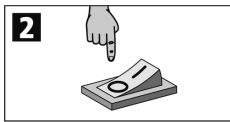
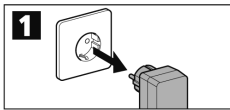
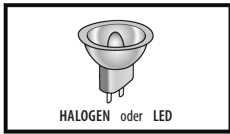

3.4 Leuchtmittel austauschen

1. Netzstecker ziehen
2. Schalter auf - 0 - stellen
3. Ring abschrauben



4. Defektes Leuchtmittel erst nach Abkühlung abziehen
5. Leuchtmittel einstecken
6. Ring aufschrauben

► 4. REINIGUNG

Die Lampe vor Reinigung ausschalten. Netzstecker ziehen und Lampenkopf abkühlen lassen.

4.1 Stativ: Die Oberfläche des Stativs kann leicht durch feuchtes Abwischen sauber gehalten werden. Sie können die üblichen Reinigungsmittel zur Reinigung verwenden. Zur etwaigen Desinfektion werden Mittel empfohlen, die entweder in Wasser oder in **max. 20% Alkohol** gelöst sind.

4.2 Leuchtenkörper: Die Leuchte ist mit einer hochwertigen Oberfläche versehen. Die Oberfläche der Leuchte kann leicht durch feuchtes Abwischen mit einem üblichen Reinigungsmittel sauber gehalten werden. Ausschließlich Desinfektionsmittel mit **weniger als 20% Alkohol** nutzen.

4.3 Praxisleuchte: **1.** Die Praxisleuchte ist desinfektionsmittelbeständig, abriebfest, urin- und blutbeständig. **2.** Die Praxisleuchte ist mit einem feuchten Tuch und alkoholischem Flächendesinfektionsmittel abzureiben. **3.** Verschmutzte Rollen reinigen, um die statische Aufladung zu vermeiden. **4.** Keine säurehaltigen Mittel verwenden.

► 5. TECHNISCHE DATEN:

Maximale Höhe: ca. 211 cm
 Oberteil Schwenkbereich: ca. 82 cm
 Durchmesser Standfuß: ca. 70 cm
 Gewicht: ca. 4,7 kg
 Netzspannung: 100 - 240 Volt
 Halogen: 12 V / 35 W / 5 A max.
 Lebensdauer der Halogen-Lampe: ≥ 1.000 h
 LED: 12V / 6,5W / 0,8 A max.
 Lebensdauer der LED-Lampe: ca. 50.000h
 Abstrahlungswinkel HL / LED: 8° / 24°

Farbtemperatur ca.: HL: 3200K/LED: 4000 Kelvin
 Beleuchtungsstärke (HL) in 30 cm Abstand 44.000 Lux
 Beleuchtungsstärke (LED) in 30 cm Abstand 31.000 Lux
 Leuchtfeldgröße (bei 0,5m Arbeitsabstand) 100 mm

Bemerkung: Die technischen Daten unterliegen Schwankungen. Dies gilt insbesondere für die Lebensdauer, Farbtemperatur und die Beleuchtungsstärke. Das Stativmodell soll auf geraden Flächen positioniert werden.

Hinweis: Die Untersuchungsleuchte ist nicht wassergeschützt! Die Anforderungen der nationalen Gremien (Normen und Direktiven) für Hygiene und Desinfektion müssen beachtet werden.

► 6. WARTUNG

Nach längerem Gebrauch müssen bei der KaWe MASTERLIGHT HL / LED Leuchte die Schrauben nachgezogen werden. Eine Wartung und Überprüfung der Leuchte muss spätestens alle zwei Jahre stattfinden.

Hinweis: Bei der Verwendung der Halogenlampe kann die Leuchte heiß werden! Bei allen Wartungs- und Prüfungsarbeiten die Leuchte ausschalten und den Netzstecker ziehen. Die Leuchte gegebenenfalls Wiedereinschalten sichern.

6.1 Regelmäßige Wartungsarbeiten: Das Tragsystem der Leuchte ist alle zwei Jahre folgenden Prüfungen/Wartungen zu unterziehen: **1.** Risse an Kunststoffteilen **2.** Funktionsprüfung **3.** Elektrische Sicherheitsprüfung **4.** Überprüfung des Tragsystems.

► 7. HINWEISE ZUR ELEKTRISCHEN INSTALLATION

Die KaWe MASTERLIGHT HL / LED Leuchte wird standardmäßig mit einem Steckernetzteil ausgeliefert.

Achtung! Steckernetzteil ist ein Gerät der Schutzklasse II.

7.1 Umgebungsbedingungen

	Betrieb	
	MIn.	Max.
Temperatur	+10° C	+40° C*
Relative Luftfeuchtigkeit	30 %	75 %
Luftdruck	700 hPa	1060 hPa

*bei höheren Temperaturen bitte Rücksprache

	Transport/Lagerung	
	MIn.	Max.
Temperatur	-10° C	+50° C
Relative Luftfeuchtigkeit	30 %	75 %
Luftdruck	700 hPa	1060 hPa

7.2 Wichtige Hinweise

Wenn mehrere Leuchten zusammen betrieben werden, kann die Gesamtbestrahlungsstärke durch Überlagerung der Leuchtfelder den Wert von 1000 W/m² überschreiten. Dadurch besteht ein Risiko zu großer Wärmeentwicklung im Leuchtfeld. Durch die Überlagerung

der Leuchtfelder mehrerer Leuchten können die Grenzwerte für UV-Strahlung (< 400 nm) von 10 W/m² überschritten werden. Wenn weitere Leuchten oder Geräte bei der Installation gemeinsam angeschlossen werden, ist der Abschnitt 16 der IEC 60601-1 A1:2012 anzuwenden und eventuell die Einhaltung der Anforderungen zu prüfen.

Die KaWe Untersuchungsleuchten unterliegen besonderen Vorsichtsmaßnahmen hinsichtlich der EMV. Die Funktion der KaWe Untersuchungsleuchte kann durch tragbare und mobile HF-Kommunikations-einrichtungen beeinflusst werden. (Beachte folgende Tabellen)

► 8. BASIS UDI-DI

4030155KaWe105K

► 9. ENTSORGUNG



Am Ende der Produktlebenszeit sollten die Bestandteile der Leuchte ordnungsgemäß entsorgt werden. Achten Sie genau auf eine sorgfältige Materialtrennung. Die elektrischen Leiterplatten sollten einer entsprechenden Recycling -Stelle zugeführt werden. Das Leuchtengehäuse und die restlichen Bestandteile der Leuchte sollten den Werkstoffen entsprechend entsorgt werden.

► 10. TABELLEN

Die KaWe Untersuchungsleuchten unterliegen besonderen Vorsichtsmaßnahmen hinsichtlich der EMV und müssen nach den in den Begleitpapieren enthaltenen EMV-Hinweisen installiert werden. Die Funktion der KaWe Untersuchungsleuchte kann durch tragbare und mobile HF-Kommunikationseinrichtungen beeinflusst werden.

Leitlinien und Herstellererklärung elektromagnetischer Ausstrahlung		
Die KaWe MASTERLIGHT HL / LED ist für den Betrieb in der unten angegebenen elektromagnetischen Umgebung bestimmt. Der Kunde oder der Anwender sollte sicherstellen, dass die Benutzung in solch einer Umgebung erfolgt.		
Ausstrahlungsmessungen	Übereinstimmung	Elektromagnetische Umgebung – Leitlinie
HF-Ausstrahlungen nach CISPR 11	Gruppe 1	Die KaWe MASTERLIGHT HL / LED verwendet HF-Energie ausschließlich zu seiner internen Funktion. Daher ist seine HF-Ausstrahlung sehr gering und es ist unwahrscheinlich, dass benachbarte elektronische Geräte gestört werden.
HF-Ausstrahlungen nach CISPR 11	Klasse B	Die KaWe MASTERLIGHT HL / LED ist für den Gebrauch in allen Einrichtungen einschließlich Wohnbereichen und solchen bestimmt, die unmittelbar an ein öffentliches Versorgungsnetz angeschlossen sind, das auch Gebäude versorgt, die für Wohnzwecke genutzt werden.
Oberschwingungen nach IEC 61000-3-2	Klasse A	
Spannungsschwankungen/Flicker nach IEC 61000-3-3	Erfüllt	

Leitlinien und Herstellererklärung elektromagnetischer Störfestigkeit

Die KaWe MASTERLIGHT HL / LED ist für den Betrieb in der unten angegebenen elektromagnetischen Umgebung bestimmt. Der Kunde oder der Anwender der KaWe MASTERLIGHT HL / LED sollte sicherstellen, dass sie in einer solchen Umgebung benutzt wird.

Störfestigkeitsprüfungen	IEC 60601 Prüfpegel	Übereinstimmungspegel	Elektromagnetische Umgebung – Leitlinien
Entladung statischer Elektrizität (ESD) nach IEC 61000-4-2	± 6 kV Kontaktentladung ± 8 kV Luftentladung	± 6 kV Kontaktentladung ± 8 kV Luftentladung	Flurböden sollten aus Holz oder Beton bestehen oder mit Keramikfliesen versehen sein. Wenn der Fußboden mit synthetischem Material versehen ist, muss die relative Luftfeuchte mindestens 30% betragen.
Schnelle transiente elektrische Störgrößen/Bursts nach IEC 61000-4-4	± 2 kV für Netzleitungen ± 1 kV für Eingangs- und Ausgangsleitungen => nicht anwendbar	± 2 kV für Netzleitungen ± 1 kV für Eingangs- und Ausgangsleitungen => nicht anwendbar	Die Qualität der Versorgungsspannung sollte der einer typischen Geschäfts- und Krankenhausumgebung entsprechen.
Stoßspannungen (Surges) nach IEC 61000-4-5	± 1 kV Gegentaktspannung ± 2 kV Gleichtaktspannung (symmetrisch)	± 1 kV Gegentaktspannung ± 2 kV Gleichtaktspannung (symmetrisch)	Die Qualität der Versorgungsspannung sollte der einer typischen Geschäfts- und Krankenhausumgebung entsprechen.
Spannungseinbrüche, Kurzzeitunterbrechungen und Schwankungen der Versorgungsspannung nach IEC 61000-4-11	< 5 % UT für ½ Periode (>95 % Einbruch der UT) 40 % UT für 5 Perioden (60 % Einbruch der UT) 70 % UT für 25 Perioden (30 % Einbruch der UT) < 5 % UT für 5 Sekunden (>95 % Einbruch der UT)	< 5 % UT für ½ Periode (>95 % Einbruch der UT) 40 % UT für 5 Perioden (60 % Einbruch der UT) 70 % UT für 25 Perioden (30 % Einbruch der UT) < 5 % UT für 5 Sekunden (>95 % Einbruch der UT)	Die Qualität der Versorgungsspannung sollte der einer typischen Geschäfts- und Krankenhausumgebung entsprechen. Wenn der Anwender der KaWe MASTERLIGHT HL / LED fortgesetzte Funktion auch beim Auftreten von Unterbrechungen der Energieversorgung fordert, wird empfohlen, KaWe MASTERLIGHT HL / LED aus einer unterbrechungsfreien Stromversorgung oder einer Batterie zu speisen.
Magnetfeld bei der Versorgungsfrequenz (50/60 Hz) nach IEC 61000-4-8	3 A/m	3 A/m	Magnetfelder bei der Netzfrequenz sollten den typischen Werten, wie sie in der Geschäfts- und Krankenhausumgebung vorzufinden sind, entsprechen.

Anmerkung: UT ist die Netzwechselfspannung vor der Anwendung der Prüfpegel.

Leitlinien und Herstellererklärung elektromagnetischer Störfestigkeit

Die KaWe MASTERLIGHT HL / LED ist für den Betrieb in der unten angegebenen elektromagnetischen Umgebung bestimmt. Der Kunde oder der Anwender der KaWe MASTERLIGHT HL / LED sollte sicherstellen, dass sie in einer solchen Umgebung benutzt wird.

Störfestigkeitsprüfungen	IEC 60601- Prüfpegel	Übereinstim- mungspegel	Elektromagnetische Umgebung – Leitlinien
Geleitete HF-Störgrößen nach IEC 61000-4-6	3 V 150 kHz bis 80 MHz	3 V	Tragbare und mobile Funkgeräte sollten in keinem geringeren Abstand zur KaWe MASTERLIGHT HL / LED einschließlich der Leitungen verwendet werden als dem empfohlenen Schutzabstand, der nach der für die Sendefrequenz zutreffenden Gleichung berechnet wird. Empfohlener Schutzabstand: $d = 1,2\sqrt{P}$ $d = 1,2\sqrt{P}$ für 80 MHz bis 800 MHz $d = 2,3\sqrt{P}$ für 800 MHz bis 2,5 GHz
Gestrahlte HF-Störgrößen nach IEC 61000-4-3	3 V/m 80 MHz bis 2,5 GHz	3 V/m	Mit P als der Nennleistung des Senders in Watt (W) gemäß Angaben des Senderherstellers und d als empfohlenem Schutzabstand in Metern (m). Die Feldstärke stationärer Funksender sollte bei allen Frequenzen gemäß einer Untersuchung vor Ort ^a geringer als der Übereinstimmungspegel sein. ^b  In der Umgebung von Geräten, die das folgende Bildzeichen tragen, sind Störungen möglich.

Anmerkung 1: Bei 80 MHz und 800 MHz gilt der höhere Frequenzbereich.

Anmerkung 2: Diese Leitlinien mögen nicht in allen Fällen anwendbar sein. Die Ausbreitung elektromagnetischer Größen wird durch Absorptionen und Reflexionen der Gebäude, Gegenstände und Menschen beeinflusst.

a: Die Feldstärke stationärer Sender, wie z. B. Basisstationen von Funktelefonen und mobilen Landfunkgeräten, Amateurfunkstationen, AM- und FM- Rundfunk- und Fernsehsender können theoretisch nicht genau vorherbestimmt werden. Um die elektromagnetische Umgebung hinsichtlich der stationären Sender zu ermitteln, sollte eine Studie des Standorts erwogen werden. Wenn die gemessene Feldstärke an dem Standort, an dem die KaWe MASTERLIGHT HL / LED benutzt wird, die obigen Übereinstimmungspegel überschreitet, sollte KaWe MASTERLIGHT HL / LED beobachtet werden, um die bestimmungsgemäße Funktion nachzuweisen. Wenn ungewöhnliche Leistungsmerkmale beobachtet werden, können zusätzliche Maßnahmen erforderlich sein, wie z. B. eine veränderte Ausrichtung oder ein anderer Standort der KaWe MASTERLIGHT HL / LED.

b: Über den Frequenzbereich von 150 kHz bis 80 MHz sollte die Feldstärke geringer als 3 V/m sein.

**Empfohlene Schutzabstände zwischen tragbaren und mobilen HF-Telekommunikationsgeräten
und der KaWe MASTERLIGHT HL / LED**

Die KaWe MASTERLIGHT HL / LED ist für den Bereich in einer elektromagnetischen Umgebung bestimmt, in der die HF-Stör-größen kontrolliert sind. Der Kunde oder der Anwender der KaWe MASTERLIGHT HL / LED kann dadurch helfen, elektromagne-tische Störungen zu vermeiden, indem er den Mindestabstand zwischen tragbaren und mobilen HF-Telekommunikationsgeräten (Sendern) und der KaWe MASTERLIGHT HL / LED – abhängig von der Ausgangsleistung des Kommunikationsgerätes, wie unten angegeben – einhält.

Nennleistung des Senders (W)	Schutzabstand abhängig von der Sendefrequenz (m)		
	150 kHz bis 80 MHz $d = 1,2\sqrt{P}$	80 MHz bis 800 MHz $d = 1,2\sqrt{P}$	800 MHz bis 2,5 GHz $d = 2,3\sqrt{P}$
0,01	0,12	0,12	0,23
0,1	0,38	0,38	0,73
1	1,20	1,20	2,30
10	3,80	3,80	7,30
100	12,00	12,00	23,00

Für Sender, deren maximale Nennleistung in obiger Tabelle nicht angegeben ist, kann der empfohlene Schutzabstand d in Metern (m) unter Verwendung der Gleichung ermittelt werden, die zur jeweiligen Spalte gehört, wobei P die maximale Nennleistung des Senders in Watt (W) gemäß Angabe des Senderherstellers ist.

Anmerkung 1: Bei 80 MHz und 800 MHz gilt der höhere Frequenzbereich.

Anmerkung 2: Diese Leitlinien mögen nicht in allen Fällen anwendbar sein. Die Ausbreitung elektromagnetischer Größen wird durch Absorptionen und Reflexionen der Gebäude, Gegenstände und Menschen beeinflusst.

► **11. GEWÄHRLEISTUNG**

Bei ordnungsgemäßer Handhabung und Berücksichtigung unserer Gebrauchsanweisung beträgt die Gewährleistung zwei Jahre beginnend mit dem Verkaufsdatum (ausgenommen Lampen/Ladebatterien). Bei weiteren Fragen oder eventuellen Reparaturen wenden Sie sich bitte an Ihren Fachhändler.



Table of contents

- 1. Safety instructions page 12
- 2. Short description of the lamp:
KaWe MASTERLIGHT HL / LED page 13
- 3. List of included parts page 13
- 3.1 Assembly instructions: 5-foot-base page 14
- 3.2 Assembly instructions: table top mount page 15
- 3.3 Assembly instructions: wall mount page 16
- 3.4 Replacing the bulb page 17
- 4. Cleaning page 17
- 4.1 Floor stand page 17
- 4.2 Light body page 17
- 4.3 Examination lamp page 17
- 5. Technical data page 17
- 6. Maintenance page 17
- 6.1 Regular maintenance requirements page 17
- 7. Electrical installation information page 18
- 7.1 Environmental conditions page 18
- 7.2 Instructions on packaging page 18
- 8. Basic UDI-DI page 18
- 9. Disposal page 18
- 10. Tables:
Electromagnetic compatibility tables page 18
- 11. Warranty page 21

Dear buyer! Thank you for choosing a KaWe product. Our products are known for high quality and durability. Our lamps comply with the provisions of Directive EU 2017/745 (European Directive on Medical Devices), whereby they are classified as class 1 medical products.

Please read these instructions thoroughly and carefully before attempting to use this product and heed the given instructions for the care of the product!

Advantages of LED technology: a bulb life of at least 50,000 hours, very bright light and hardly any noticeable heat build-up on the surgeon's forehead or on the area of the patient's body that is being examined. The advantages of KaWe's conventional illumination technology with halogen bulbs have been maintained: natural colour reproduction, exact illumination of the treatment area and easy positioning of the lamp body.

1. SAFETY INSTRUCTIONS

When handling the light, the instructions given in the User's Manual must be followed.

WARNING : This device is not intended for use in areas in which explosions may occur.

Please read these instructions thoroughly and carefully and familiarise yourself fully with this product before using it in order to benefit from all the advantages of the lamp system and to avoid the possibility of damaging it.

Maintenance work on the lamp, especially assembly, is only to be carried out by authorised personnel.

The safety of the lamp is only guaranteed by the manufacturer if repairs and changes are performed by the manufacturer itself or by a location that guarantees that the safety rules will be followed.

WARNING: The lamp may not be modified in any way!

The manufacturer is not responsible for damage to persons or other objects if the lamp is used incorrectly or for a non-intended purpose. The KaWe MASTERLIGHT HL / LED cannot be combined with any other devices.



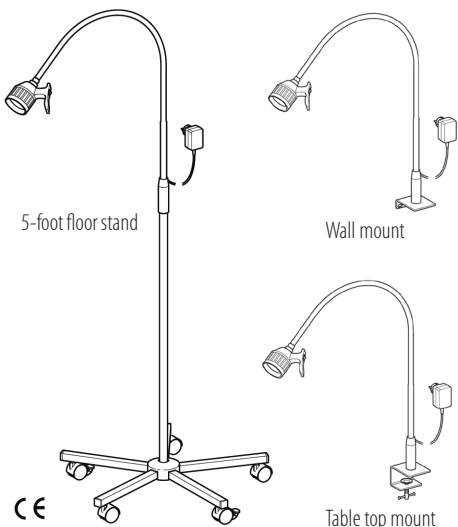











Prior to each use, check the lamp to ensure that it is in perfect working order.



General instructions

- All KaWe floor lamps come equipped with all of the parts required for assembly and connection.
- Mounting is carried out on the stand, on the wall or on the table.
- Due to packaging requirements, the five-footed base of the stand comes unassembled. The stand post is always delivered as one piece and needs only to be connected to the base with the fastening screw, which is found on the bottom of the post.
- The lamp includes an integrated power cable and shock-proof plug.
- The type of outlet used must be installed in a manner that complies with IEC and VDE 0100-710 requirements.

Symbol key:

	Manufacturer
	Date of manufacture
	Lot code
	Please follow the User's Manual
	Caution! During assembly and when replacing bulb
	Temperature limit
	Separate disposal of electric and electronic devices
	Complies with relevant EU guidelines
	MEDICAL DEVICE
	GOST-R certification of export goods imported into Russia
	Air humidity limitation
	Device safety class: II
	Fragile
	Keep dry
	Electromagnetic field warning

► 2. SHORT DESCRIPTION OF THE LAMP

KaWe MASTERLIGHT HL / LED

Intended use:

The lamps serve as illumination during the treatment and diagnosis process in hospitals or doctors' offices. They illuminate the work area and the patient's body with a shadow-free, cold, high power light.

Application:

The lamps can only be used by authorized trained personnel!

Group of patients with indications for use:

All patient groups

► 3. LIST OF INCLUDED PARTS

- 1x floor stand mounting block
- 2x feet with locking castors
- 3x feet without locking castors
- 1x stand post
- 1x stand cap
- 1x fillister head screw with washer
- 1x flat spanner
- Lamp body with arm
- User's manual

Information for users and patients:

All serious incidents involving this device must be immediately reported to the manufacturer and the competent authorities of the respective Member State in which the user and/or patient is located.



3.1 Assembly instructions: 5-foot-floor stand

en

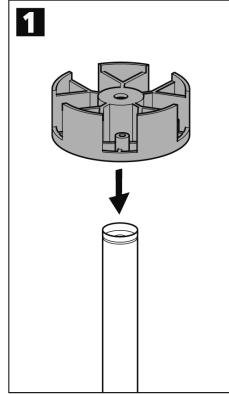
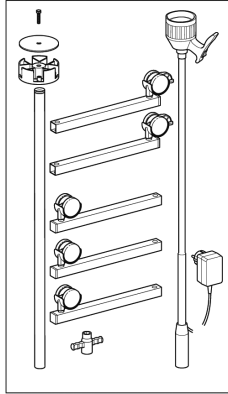
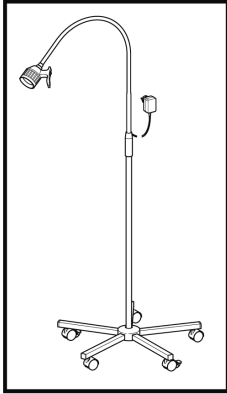

Mounting parts

1. Attach the block.

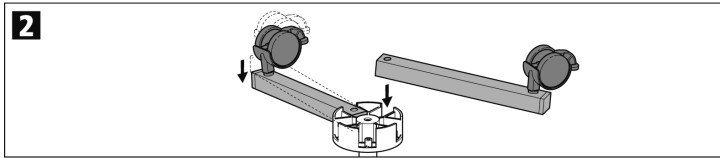

2. Attach two foot pieces with brake rollers opposite one another.

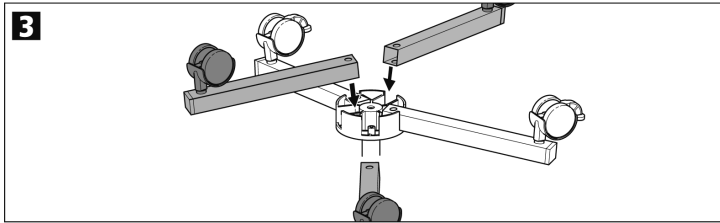

3. Attach three foot pieces without brake rollers.

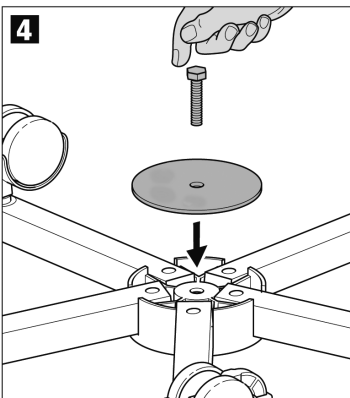

4. Screw in hexagon head screw.

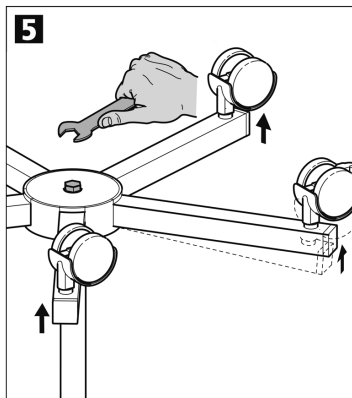

5. Tighten the hexagon head screw.

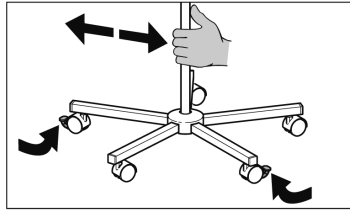
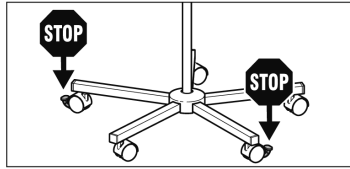
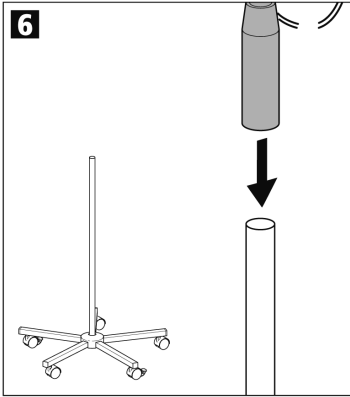

6. Push the upper part of the examination lamp onto the floor stand post.

Lock the brake rollers.
Loosen the brake rollers to move the examination lamp.



3.2 Assembly instructions: table top mount

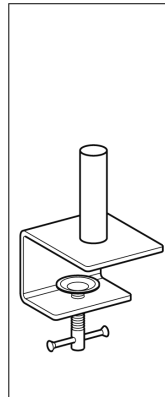
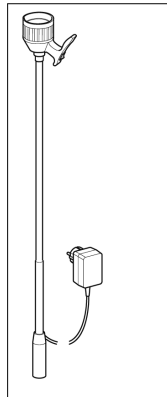
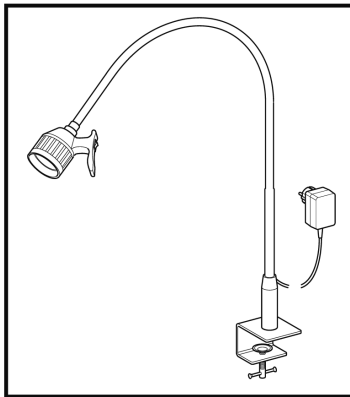

Mounting parts

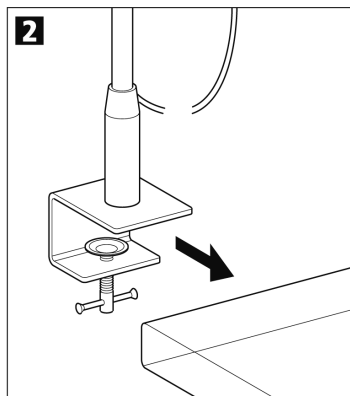
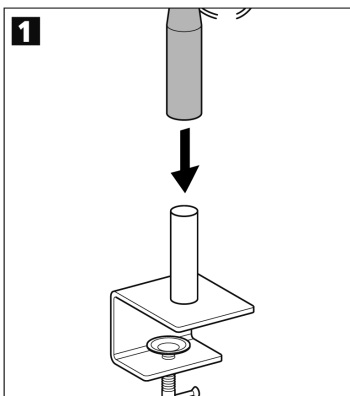

1. Push upper part of examination lamp onto table clamp.
2. Fasten examination lamp to the table top.

3.3 Assembly instructions: wall mount

en

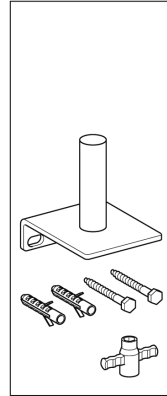
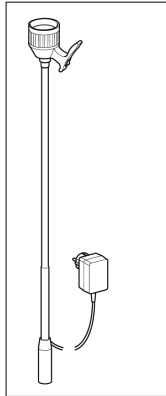
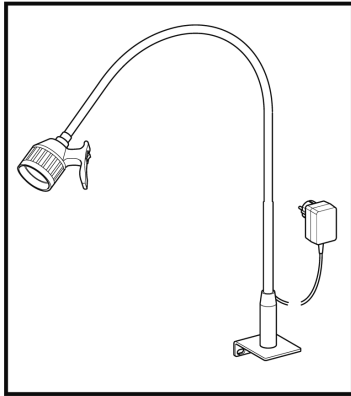

Mounting parts

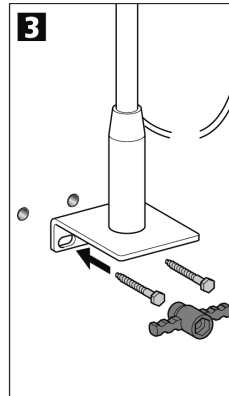
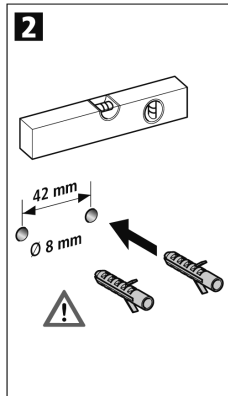
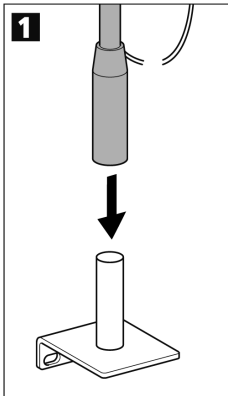

1. Push upper part of examination lamp onto the wall bracket.
2. Use caution when drilling! Check the wall for electric lines, gas and water conduits.
3. Affix examination lamp to the wall.

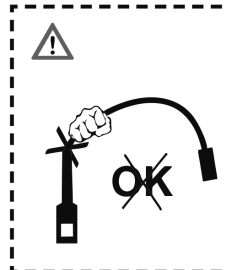
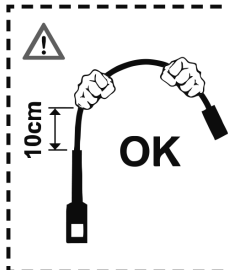
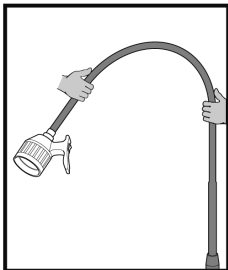

Adjust position of light with both hands.

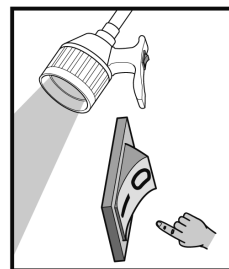
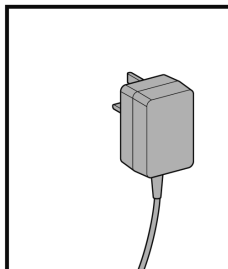
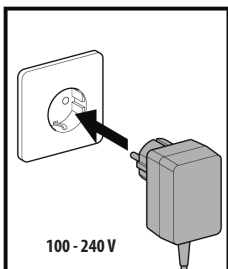

Electric supply (EU / GB)

Turn ON - I -
Turn OFF - 0 -

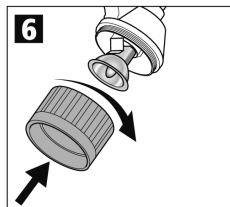
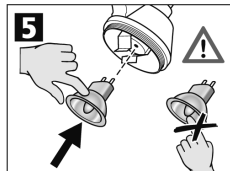
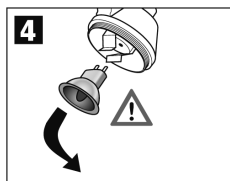
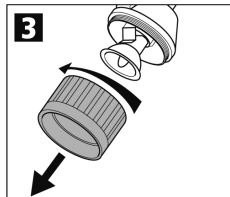
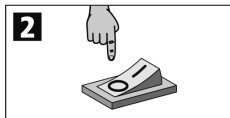
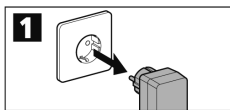
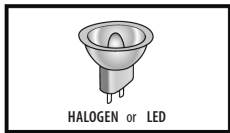

3.4 Replacing the bulb

1. Disconnect the power plug.
2. Set switch to - 0 -.
3. Unscrew the ring.



4. Remove defective bulb only after it has cooled down.
5. Insert new bulb.
6. Screw the ring back on.



► 4. CLEANING

Before cleaning, turn off the lamp. Unplug the power cord and allow the lamp head to cool.

4.1 Floor stand: The surface of the floor stand can be kept clean by wiping it gently with a damp cloth. Any common cleaning agent may be used. For disinfection, we recommend a solution that is either dissolved in water or **max. 20% alcohol**.

4.2 Light body: The lamp is made with a high quality surface material. The surface of the light can be easily kept clean by wiping it with a damp cloth and any common cleaning agent. Only use disinfecting agents with an alcohol content of **less than 20%**.

4.3 Examination lamp: **1.** The examination lamp is resistant to disinfectants, abrasion, urine and blood. **2.** The examination lamp is to be wiped with a damp cloth and alcohol-based surface disinfectant. **3.** Clean dirty castors in order to avoid static charge. **4.** Do not use agents containing acids.

► 5. TECHNICAL DATA

Max. height:	approx. 211 cm
Lamp arm pivoting range:	approx. 82 cm
Diameter of floor stand base:	approx. 70 cm
Weight:	approx. 4.7 kg
Supply voltage:	100 - 240 Volt
Halogen:	12 V / 35 W / 5 A max.
Life of the halogen bulb:	≥ 1.000 h
LED:	12 V / 6,5W / 0,8 A max.
Life of the LED lamp:	approx. 50.000h
Beam angle HL / LED:	8° / 24°

Colour temperature ca.:	HL: 3200K/LED: 4000K
Illumination intensity (HL) at a distance of 30 cm	44.000 Lux
Illumination intensity (LED) at a distance of 30 cm	31.000 Lux
Light spot size (at a working distance of 0.5m)	100 mm

Note: The technical data are subject to certain fluctuations, especially with regard to the product life, color temperature and illumination intensity. The floor stand model should be placed on level surfaces.

Information: The examination lamp is not water proof! National board requirements (standards and directives) for hygiene and disinfection must be followed.

► 6. MAINTENANCE

After being used for a longer period of time, the KaWe MASTERLIGHT HL / LED lamp screws must be tightened. The lamp is to be serviced and checked at least every two years.

Information: The halogen lamp can become hot during use!

When servicing and or checking the unit, turn it off and disconnect the plug. Insure that the lamp cannot be turned back on.

6.1 Regular maintenance: The structural system of the lamp is to be checked/serviced every two years: **1.** Cracks in plastic parts **2.** Functionality test **3.** Electrical safety test **4.** Structural system check.



► 7. ELECTRICAL INSTALLATION INFORMATION

The KaWe MASTERLIGHT HL / LED lamp comes with a power adaptor.

Caution! The power adaptor is a protection class II unit.

7.1 Environmental conditions

	Operation	
	Min.	Max.
Temperature	+10° C	+40° C*
Relative humidity	30 %	75 %
Air pressure	700 hPa	1060 hPa

*for higher temperatures, please consult manufacturer

	Transport/Storage	
	Min.	Max.
Temperature	-10° C	+50° C
Relative humidity	30 %	75 %
Air pressure	700 hPa	1060 hPa

7.2 Important information

If multiple lamps are used at once, the total irradiance may exceed 1,000 W/m² due to superposition of the luminous fields. As a result, there is a risk that the illuminated field may become very hot. The superposition of the luminous fields of multiple lights may cause the limit values for UV radiation (<400 nm) of 10 W/m² to be exceeded.

If other lights or appliances are connected together during installation, section 16 of EN 60601-A1:2012 applies and if necessary, the compliance with the requirements is to be verified. KaWe examination lamps are subject to special safety measures with regard to electromagnetic compatibility. The function of KaWe examination lamps can be influenced by high-frequency communication devices. (Heed the following tables.)

► 8. BASIC UDI-DI

4030155KaWe10SK

► 9. DISPOSAL



At the end of its product life, the lamp's components are to be disposed of properly. Ensure that the materials are sorted carefully according to type. The electrical circuit boards are to be disposed of at an appropriate recycling centre. The lamp's housing and the rest of the components should be disposed of according to their type of material.

► 10. TABLES

These KaWe examination lights are subject to special safety measures with regard to EMC requirements and must be installed in accordance with the enclosed EMC instructions. The functionality of these KaWe examination lights can be influenced by portable and mobile HF communication devices.

Guidelines and manufacture declaration – Electromagnetic emissions

The KaWe MASTERLIGHT HL / LED is designed to be used in the types of electromagnetic environments listed below. The customer or user is responsible for ensuring that this device is used in such an environment.

Emissions Measurement	Conformity	Electromagnetic environment – Guidelines
Type-CISPR 11 – high-frequency emissions	Group 1	The KaWe MASTERLIGHT HL / LED uses high-frequency energy solely for its internal OPERATION. Its high-frequency emissions are therefore very low and it is unlikely that any nearby electronic equipment will be adversely effected.
Type-CISPR 11 – high-frequency emissions	Class B	The KaWe MASTERLIGHT HL / LED is designed for use in all facilities including living spaces that are directly connected to a public low-voltage power supply network that also supplies power to buildings used for domestic purposes.
Harmonic oscillations according to IEC 61000-3-2	Class A	
Voltage fluctuations / flicker emissions according to IEC 61000-3-3	Complies	

Guidelines and Manufacturer Declaration – Electromagnetic Interference Immunity

The KaWe MASTERLIGHT HL / LED is designed to be used in the types of environments listed below.

The customer or user of the KaWe MASTERLIGHT HL / LED is responsible for ensuring that this device is used in such an environment.

Interference immunity test	IEC 60601-test level	Compliance level	Electromagnetic environment – guidelines
Electrostatic discharge (ESD) according to IEC 61000-4-2	± 6kV contact discharge ± 8 kV air discharge	± 6kV contact discharge ± 8 kV air discharge	The flooring should be wood or concrete or be covered with ceramic tile. If the floor material is a non-conductive, synthetic material, the relative humidity of the air must be at least 30%.
Fast transient electrical disturbances/ bursts according to IEC 61000-4-4	± 2kV for power supply lines ± 1kV for input and output lines => not applicable	± 2kV for power supply lines ± 1kV for input and output lines => not applicable	The quality of the mains supply voltage should be the same as that of a typical commercial or hospital environment.
Surges according to IEC 61000-4-5	± 1 kV differential mode voltage ± 2 kV common mode voltage	± 1 kV differential mode voltage ± 2 kV common mode voltage	The quality of the mains supply voltage should be the same as that of a typical commercial or hospital environment.
Voltage dips, short interruptions and voltage variations on power supply input lines according to IEC 61000-4-11	< 5 % UT (>95 % dip in the UT) for a ½ period 40 % UT (60 % dip in the UT) for 5 periods 70 % UT (30 % dip in the UT) for 25 periods < 5 % UT (>95 % dip in the UT) for 5 seconds	< 5 % UT (>95 % dip in the UT) for a ½ period 40 % UT (60 % dip in the UT) for 5 periods 70 % UT (30 % dip in the UT) for 25 periods < 5 % UT (>95 % dip in the UT) for 5 seconds	The quality of the mains supply voltage should be the same as that of a typical commercial or hospital environment. If the user of the KaWe MASTERLIGHT HL / LED requires continued operation during power interruptions, it is recommended that the KaWe MASTERLIGHT HL / LED be powered from an uninterruptable power supply or a battery.
Magnetic field with a power frequency of (50/60 Hz) according to IEC 61000-4-8	3 A/m	30 A/m	Magnetic fields with their line frequencies should be the same as those typical of commercial and hospital environments.

Note: Ut is the mains voltage prior to application of the test level.



Guidelines and Manufacturer Declaration – Electromagnetic Interference Immunity

The KaWe MASTERLIGHT HL / LED is designed to be used in the types of environments listed below. The customer or user of the KaWe MASTERLIGHT HL / LED is responsible for ensuring that this device is used in such an environment.



Interference immunitytest	IEC 60601-test level	Compliance level	Electromagnetic environment – guidelines
Conducted HF-interference according to IEC 61000-4-6	3 V 150 kHz to 80 MHz	3 V	<p>Portable and mobile HF communications equipment should be used no closer to the KaWe MASTERLIGHT HL / LED (including its power cords) than the recommended separation distance. The separation distance is calculated using various equations depending on the transmission frequency.</p> <p>Recommended separation distance: $d = 1.2\sqrt{P}$ $d = 1.2\sqrt{P}$ for 80 MHz to 800 MHz $d = 2.3\sqrt{P}$ for 800 MHz to 2.5 GHz</p>
Radiated HF-interference according to IEC 61000-4-3	3 V/m 80 MHz to 2.5 GHz	3 V/m	<p>“P” is the maximum output power rating of the transmitter in watts (W) according to the transmitter manufacturer. “d” is the recommended separation distance in meters (m). Field strengths from fixed transmitters, as determined by an electromagnetic survey of site “a” are less than the COMPLIANCE LEVEL in each frequency range.</p> <p> Interference may occur in the vicinity of equipment marked with the following symbol.</p>

Note 1: For 80 MHz and 800 MHz, the larger of the two values applies.

Note 2: These guidelines may not apply in all situations. Electromagnetic propagation is affected by absorption and reflection from structures, objects and people.

a: Field strengths from fixed transmitters, such as base stations for radio (cellular/cordless) telephones and land mobile radios, amateur radio, AM and FM radio broadcast and TV broadcast cannot be predicted with accuracy in theory. It is recommended that in order to assess the electromagnetic environment caused by fixed HF transmitters, an electromagnetic site survey should be conducted. If the measured field strength at the location at which the KaWe MASTERLIGHT HL / LED is used exceeds the applicable compliance level stated above, the equipment should be checked at each of its locations of use in order to verify normal operation. If abnormal performance is observed, additional measures may be necessary, such as reorienting or relocating the KaWe MASTERLIGHT HL / LED.

b: For frequencies ranging from 150 kHz to 80 MHz, the field strength is less than 3 V/m.

Recommended Separation Distances Between Portable and Mobile HF Communications Equipment and the KaWe MASTERLIGHT HL / LED



The KaWe MASTERLIGHT HL / LED is intended for use in an electromagnetic environment in which radiated HF disturbances are controlled. The customer or the user of the equipment can help prevent electromagnetic interference by ensuring that the minimum distance (shown below) between communications equipment (transmitters) and the KaWe MASTERLIGHT HL / LED is maintained. The minimum distance is dependent on the maximum output power and the frequency of the communications equipment.

Rated Power Output of Transmitter (W)	Separation Distance According to Transmitter Frequencies (m)		
	150 kHz to 80 MHz $d = 1.2\sqrt{P}$	80 MHz to 800 MHz $d = 1.2\sqrt{P}$	800 MHz to 2.5 GHz $d = 2.3\sqrt{P}$
0.01	0.12	0.12	0.23
0.1	0.38	0.38	0.73
1	1.20	1.20	2.30
10	3.80	3.80	7.30
100	12.00	12.00	23.00

For transmitters rated at a maximum output power not listed above, the recommended separation distance can be determined using the equation applicable to the frequency of the transmitter. P is the maximum output power rating of the transmitter in watts (W) according to the transmitter manufacturer.

Note 1: For 80 MHz and 800 MHz, the larger of the two values applies.

Note 2: These guidelines may not apply in all situations. Electromagnetic propagation is affected by absorption and reflection from structures, objects and people.

► **11. WARRANTY**

The warranty is two years after the sale, provided that the device was operated as intended and according to this User's Manual (except for illumination sources, batteries and rechargeable batteries). If you have any questions, or your device requires repair, please contact your supplier.



Mode d'emploi Lampe d'examen KaWe MASTERLIGHT HL / LED

Sommaire

1. Consignes de sécurité	page 22
2. Description sommaire de la lampe KaWe MASTERLIGHT HL / LED	page 23
3. Matériel fourni	page 23
3.1 Instructions de montage :	
Piètement à 5 branches	page 24
3.2 Instructions de montage : Fixation sur la table	page 25
3.3 Instructions de montage : Fixation murale	page 26
3.4 Échanger le luminaire	page 27
4. Nettoyage	page 27
4.1 Piètement.....	page 27
4.2 Corps de lampe	page 27
4.3 Lampe d'examen	page 27
5. Données techniques	page 27
6. Maintenance	page 27
6.1 Travaux de maintenance réguliers	page 27
7. Instructions concernant l'installation électrique	page 28
7.1 Conditions ambiantes	page 28
7.2 Remarques importantes	page 28
8. IUD-ID de base.....	page 28
9. Elimination	page 28
10. Tableaux : Informations sur la compatibilité électromagnétique	page 28
11. Garantie légale	page 31

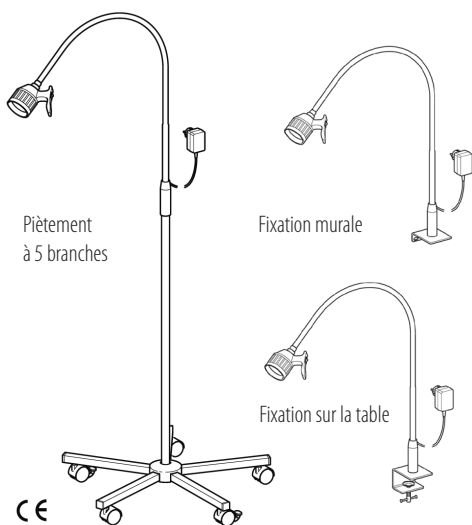

Cher client, merci d'avoir choisi un produit KaWe. Nos produits se distinguent par leur haute qualité et la durabilité élevée. Les lampes sont conformes aux dispositions du règlement (CE) 2017 / 745 (directive euro-péenne sur les dispositifs médicaux) et, conformément à cette directive, sont des produits médicaux de classe I.

ⓘ Veuillez lire ce mode d'emploi attentivement et entièrement avant d'utiliser le produit et respecter les consignes d'entretien.

Les avantages de la technologie LED sont les suivants : une durée de vie de 50.000 heures au moins, une haute luminosité et un développement de chaleur quasi imperceptible tant au niveau de la tête du chirurgien qu'au niveau de la plaie. Nous avons gardé néanmoins les atouts de la technique d'éclairage par lampes halogènes utilisée par KaWe jusqu'à maintenant : le rendu naturel des couleurs, l'éclairage parfait de la plaie et la facilité de positionnement du corps de lampe.

► 1. CONSIGNES DE SÉCURITÉ

Pour la manipulation de la lampe, il faut suivre le mode d'emploi.

PRUDENCE : L'appareil n'est pas destiné à être utilisé en atmosphères explosives.

Veuillez lire attentivement le présent mode d'emploi pour profiter de tous les avantages du système d'éclairage et éviter les éventuels endommagements du système.

La remise en bon état de la lampe et surtout les travaux de montage ne doivent être réalisés que par du personnel qualifié.

La sécurité de la lampe est garantie par le fabricant uniquement si les réparations et les modifications ont été effectuées directement par celui-ci ou par un organisme garantissant que les règles de sécurité sont respectées.

PRUDENCE : Il est strictement interdit de modifier la lampe !















Le fabricant décline toute responsabilité en cas de dommages corporels ou matériels si la lampe a été opérée ou utilisée à des fins autres que prévues ou de manière erronée. La lampe KaWe MASTERLIGHT HL / LED ne peut pas être combinée avec d'autres appareils.

Assurez-vous avant chaque emploi de la lampe qu'elle est en parfait état.

Remarques générales

- A la livraison, toutes les lampes sur pied de KaWe sont accompagnés de la totalité des pièces nécessaires au montage et au branchement.
- Le montage se fait sur un trépied, sur un mur ou sur une table.
- Pour des raisons d'emballage, le pied roulant à cinq branches est livré démonté. Le tube du pied est toujours monté d'une pièce, il suffira de l'adapter sur le piètement et de serrer la vis de fixation inférieure.
- La lampe est livrée avec câble de branchement intégré et fiche de prise de courant de sécurité.
- La prise de courant utilisée doit être conforme aux exigences de la norme allemande VDE 0100-710 ou de la norme internationale CEI correspondante.

Explication des symboles :

	Fabricant
	Date de fabrication
	Code de lot
	Veuillez respecter le mode d'emploi
	Prudence lors du montage et pendant l'échange du luminaire !
	Limite de température
	Tri sélectif des déchets électriques et électroniques
	Respect des directives CE pertinentes
	Dispositif médical
	Certification GOST-R des marchandises d'ex- portation importées en Russie
	Limitation de l'humidité de l'air
	Classe de protection II
	Produit fragile
	Craint l'humidité
	Avertissement de champ électromagnétique

► 2. DESCRIPTION SOMMAIRE DE LA LAMPE KaWe MASTERLIGHT HL / LED

Consignes d'utilisation :

Les lampes sont conçues pour faciliter le traitement et le diagnostic dans un hôpital ou un cabinet médical. Ils éclairent la zone de travail et le corps du patient avec une lumière « froide » très puissante et sans ombre.

Champ d'application :

Ce produit ne doit être utilisé que par du personnel qualifié et autorisé!

Population de patients visée :

Tous les groupes de patients



► 3. MATÉRIEL FOURNI

- 1 bloc de montage du piètement
- 2 branches avec roulettes à frein
- 3 branches avec roulettes sans frein
- 1 tube de pied
- 1 capuchon pour piètement
- 1 vis à tête cylindrique M8 avec rondelle
- 1 clé à fourche
- Corps de lampe avec bras
- Mode d'emploi

Remarque pour l'utilisateur et le patient :

Nous vous recommandons de signaler immédiatement tout incident grave impliquant le produit au fabricant et aux autorités compétentes de l'État membre dans lequel se trouve l'utilisateur et / ou le patient.

3.1 Instructions de montage : Piètement à 5 branches

fr

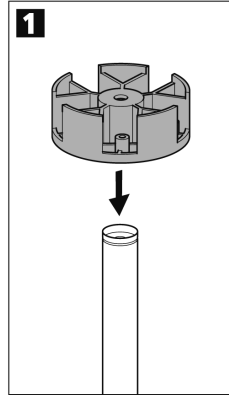
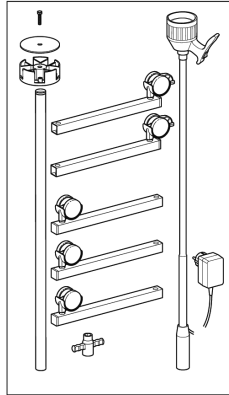
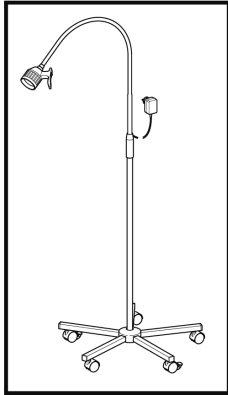

Pièces de montage

1. Emboîter le bloc.

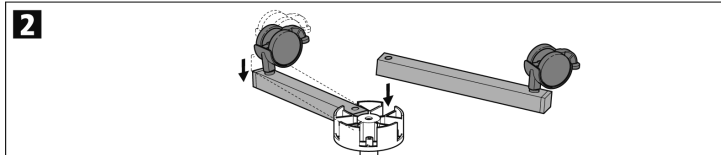

2. Accrocher les deux branches pourvues de roulettes à frein en position opposée.

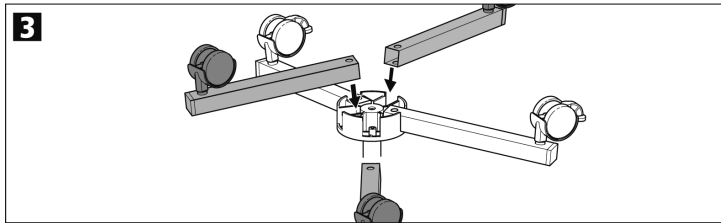

3. Accrocher les trois branches sans roulettes à frein.

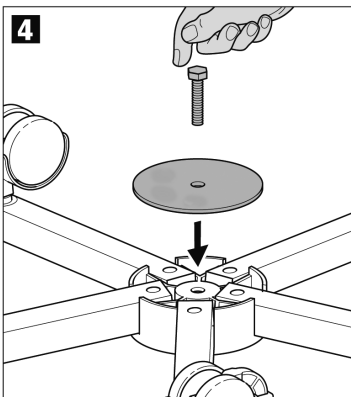

4. Visser la vis à six pans.

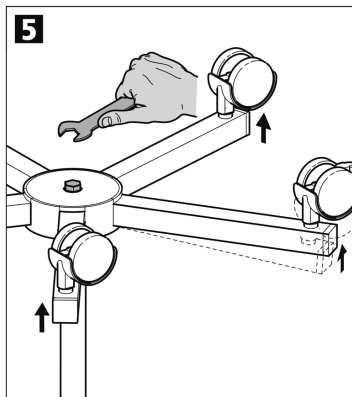

5. Serrer la vis à six pans.

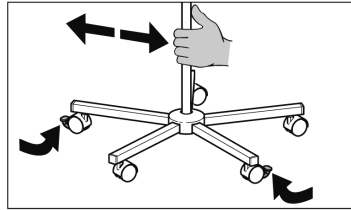
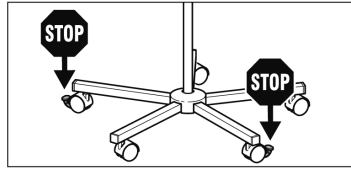
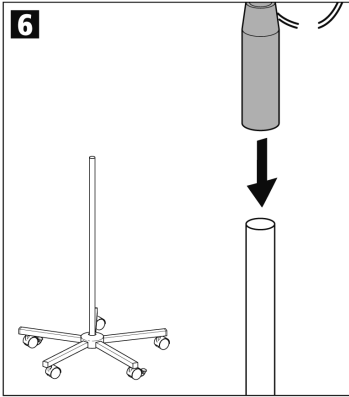

6. Mettre la partie supérieure de la lampe d'examen sur la partie inférieure.

Bloquer les roulettes à frein. Débloquer les roulettes à frein pour le déplacement.



3.2 Instructions de montage : Fixation sur table

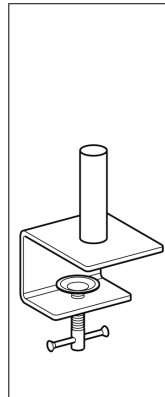
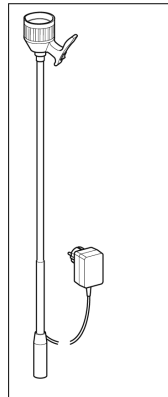
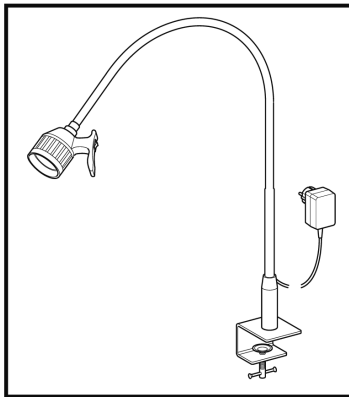

Pièces de montage

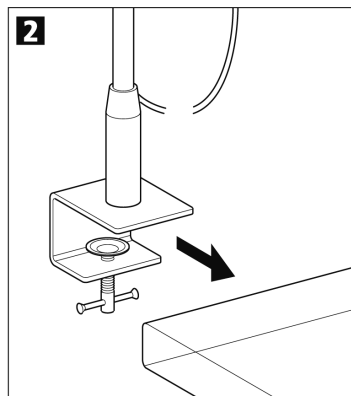
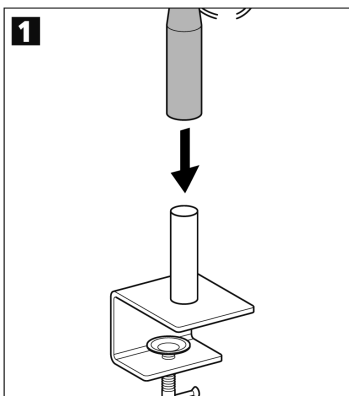

1. Mettre la partie supérieure de la lampe d'examen sur la pince pour fixation sur table.

2. Visser la lampe d'examen sur le dessus de table.

3.3 Instructions de montage : Fixation murale

fr

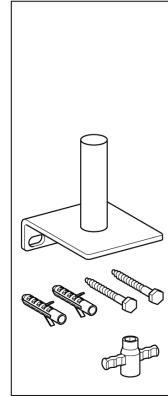
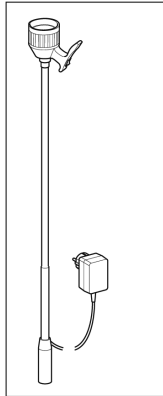
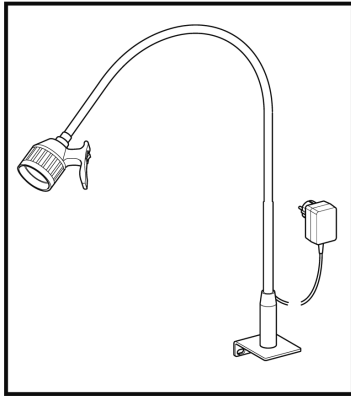

Pièces de montage

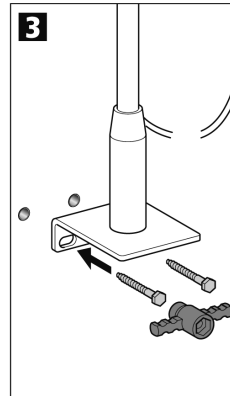
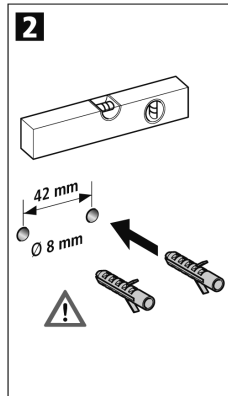
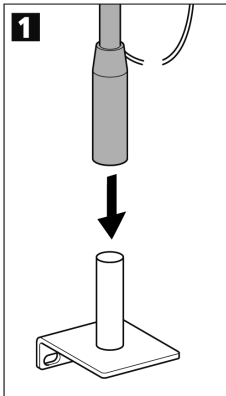

1. Mettre la partie supérieure de la lampe d'examen sur l'équerre pour fixation murale.



2. Attention au moment de percer les trous ! Vérifier qu'il n'y a pas de conduites électriques, à gaz ou à eau qui passent par le mur.

3. Visser la lampe d'examen sur le mur.

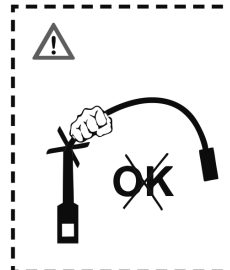
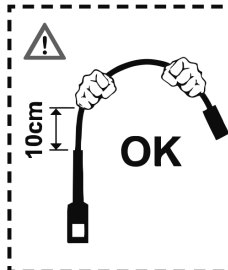
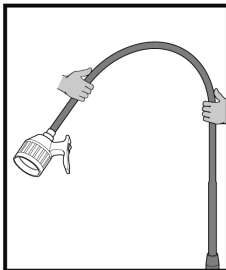

Pour régler le sens de la lumière, se servir toujours des deux mains.

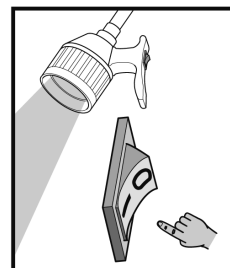
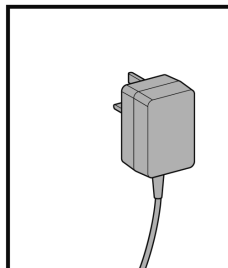
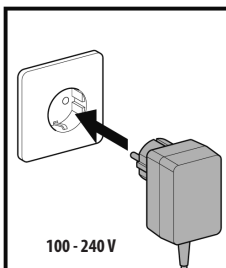

Branchement sur le secteur (UE / GB)

MARCHE - I -
ARRÊT - 0 -

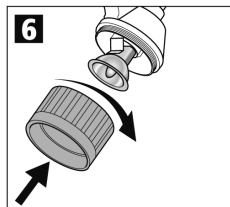
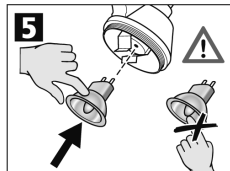
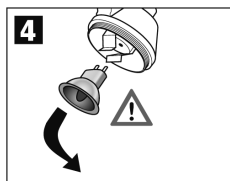
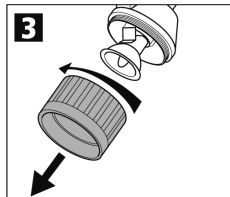
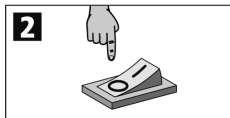
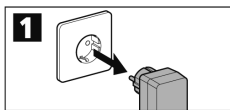

3.4 Échanger le luminaire

1. Retirer la fiche de secteur.
2. Mettre l'interrupteur en position - 0 -.
3. Dévisser l'anneau.



4. Attendre que le luminaire défectueux ait refroidi et le retirer ensuite.
5. Engager le luminaire.
6. Visser l'anneau.

fr

► 4. NETTOYAGE

Éteindre la lampe avant son nettoyage. Tirer la fiche de secteur et laisser refroidir la tête de la lampe.

4.1 Piètement : La surface du piètement se nettoie facilement avec une lingette humide. Pour le nettoyer, se servir de produits de nettoyage courants. Pour le désinfecter, il est recommandé d'utiliser des produits dissous dans l'eau ou contenant **20% d'alcool max.**

4.2 Corps de lampe : La surface de la lampe dispose d'un revêtement de qualité supérieure. Elle se nettoie facilement avec une lingette humide imbibée de produit de nettoyage courant. Utiliser exclusivement des désinfectants dont le contenu en alcool est **inférieur à 20%**.

4.3 Lampe d'examen : **1.** La lampe d'examen résiste aux désinfectants, ainsi qu'à l'usure et aux taches d'urine et de sang. **2.** La lampe d'examen doit être frottée avec une lingette humide et un produit de désinfection des surfaces contenant de l'alcool. **3.** Nettoyer les roulettes souillées pour éviter l'effet de la charge électrostatique. **4.** Ne jamais utiliser des produits acides.

► 5. DONNÉES TECHNIQUES :

Hauteur maximale : 211 cm env.
 Plage de pivotement de la partie supérieure : 82 cm env.
 Diamètre du piètement : 70 cm env.
 Poids : 4,7 kg env.
 Tension de réseau : 100 - 240 V
 Halogène : 12V / 35W, 5 A max.
 Durée de vie de l'ampoule halogène : ≥ 1.000 h
 LED : 12V / 6,5W/ 0,8 A max.
 Durée de vie de l'ampoule LED : 50.000h env.
 Angle de rayonnement HL / LED : 8° / 24°
 Température de la couleur env. : HL: 3200K/LED: 4000K
 Intensité lumineuse (HL) à une distance de 30 cm 44.000 lux
 Intensité lumineuse (LED) à une distance de 30 cm 31.000 lux

Taille du champ lumineux

(à une distance de travail de 0,5 m) : 100 mm

Remarque : Les données techniques peuvent être soumises à des variations. Cela vaut surtout pour la durée de vie, la température de la couleur et l'intensité lumineuse. Le modèle avec pied roulant doit être positionné sur des surfaces planes.

Remarque : La lampe d'examen n'est pas protégée contre l'eau ! Les exigences des organismes nationaux (normes et directives) pour l'hygiène et la désinfection doivent être respectées.

► 6. MAINTENANCE

Après un certain temps d'emploi, il faut revisser les vis de la lampe KaWe MASTERLIGHT HL / LED. La maintenance et le contrôle de la lampe doivent être réalisés tous les deux ans au plus tard.

Remarque : Si la lampe est équipée d'une ampoule halogène, la lampe peut se réchauffer ! Pour tout travail de maintenance et d'inspection, éteignez la lampe et retirez la fiche de secteur. Assurez la lampe contre toute remise en circuit.

6.1 Travaux de maintenance réguliers : Tous les deux ans, le système porteur de la lampe doit être soumis aux contrôles / travaux de maintenance suivants : **1.** Fissures dans les pièces en plastique **2.** Vérification du fonctionnement **3.** Vérification de la sécurité du système électrique **4.** Vérification du système porteur.



► 7. INSTRUCTIONS CONCERNANT L'INSTALLATION ÉLECTRIQUE

La lampe KaWe MASTERLIGHT HL / LED est livrée avec un bloc d'alimentation enfichable standard.

Prudence ! Le bloc d'alimentation enfichable est un appareil de la classe de protection II.

7.1 Conditions ambiantes

	Fonctionnement	
	MIn.	Max.
Température	+10° C	+40° C*
Humidité relative de l'air	30 %	75 %
Pression atmosphérique	700 hPa	1060 hPa

*pour des températures plus élevées, veuillez nous contacter

	Transport et emmagasinage	
	MIn.	Max.
Température	-10° C	+50° C
Humidité relative de l'air	30 %	75 %
Pression atmosphérique	700 hPa	1060 hPa

7.2 Remarques importantes

Si plusieurs lampes sont exploitées en même temps, l'intensité d'irradiation totale peut dépasser la valeur de 1000 W/m² en raison d'une superposition des champs lumineux. Dans ce cas, vous risquez d'avoir un développement de chaleur excessif dans le champ lumineux. Suite à la superposition des champs lumineux de plusieurs lampes, les valeurs du rayonnement UV (< 400 nm) peuvent dépasser la valeur limite de 10 W/m². Si d'autres lampes ou appareils sont connectés sur un même réseau pendant l'installation, il faut appliquer le paragraphe 16 de la norme EN 60601-A1:2012 et vérifier, le cas échéant, le respect des exigences. Les lampes d'examen KaWe sont soumises à des mesures de précaution spécifiques concernant la CEM. Le fonctionnement de la lampe d'examen KaWe peut être affecté par les appareils de communication RF portables et mobiles. (voir les tableaux suivants)

► 8. IUD-ID DE BASE

4030155KaWe10SK

► 9. ELIMINATION



A la fin du cycle de vie du produit, les composants de la lampe doivent être éliminés de manière conforme. Veillez à trier soigneusement les matériaux. Les plaquettes électriques devraient être recyclées de manière appropriée. Le corps de lampe et les autres composants du luminaire devraient être éliminés selon le tri sélectif.

► 10 TABLEAUX

Les lampes d'examen KaWe sont soumises à des mesures de précaution spécifiques concernant la CEM et doivent être installées conformément aux instructions CEM spécifiées dans les documents d'accompagnement. Le fonctionnement de la lampe d'examen KaWe peut être affecté par les appareils de communication RF portables et mobiles.

Lignes de conduite et déclaration du fabricant – émissions électromagnétiques		
La lampe MASTERLIGHT HL / LED doit être utilisée dans l'environnement électromagnétique ci-dessous. Le client ou l'utilisateur du matériel doit s'assurer que ces conditions sont respectées.		
Mesures des émissions	Conformité	Environnement électromagnétique – Lignes de conduite
Émissions RF selon CISPR 11	Groupe 1	La lampe KaWe MASTERLIGHT HL / LED utilise l'énergie RF uniquement pour sa fonction interne. Par conséquent, ses émissions RF sont très faibles et ne sont susceptibles de provoquer d'interférence dans un équipement électronique à proximité.
Émissions RF selon CISPR 11	Classe B	La lampe KaWe MASTERLIGHT HL / LED peut être utilisée dans tous les établissements, y compris à domicile, et ceux directement branchés à un réseau d'alimentation public alimentant les bâtiments utilisés à des fins domestiques.
Émissions de courant harmonique selon IEC 61000-3-2	Classe A	
Fluctuations de tensions/ Flicker selon IEC 61000-3-3	Conforme	

Lignes de conduite et déclaration du fabricant – Immunité électromagnétique

La lampe KaWe MASTERLIGHT HL / LED doit être utilisée dans l'environnement électromagnétique spécifié ci-dessous.
Le client ou l'utilisateur de la lampe KaWe MASTERLIGHT HL / LED doit veiller à utiliser le dispositif dans cet environnement.

Tests d'immunité	Niveau IEC 60601	Niveau de conformité	Environnement électromagnétique – Lignes de conduite
Décharge électrostatique (DES) selon IEC 61000-4-2	± 6 kV contact ± 8 kV air	± 6 kV contact ± 8 kV air	Les sols doivent être revêtus de bois, de béton ou de carrelage céramique. Si les sols sont conçus à partir d'un matériau synthétique, l'humidité relative doit atteindre au moins 30 %.
Transitoires électriques rapides en salves selon IEC 61000-4-4	± 2 kV pour les lignes d'alimentation ± 1 kV pour les lignes d'entrée et de sortie => sans emploi dans ce cas	± 2 kV pour les lignes d'alimentation ± 1 kV pour les lignes d'entrée et de sortie => sans emploi dans ce cas	La qualité du secteur électrique doit être identique à celle d'un environnement commercial et hospitalier conventionnel.
Pointes d'énergie selon IEC 61000-4-5	± 1 kV mode différentiel ± 2 kV mode commun (symétrique)	± 1 kV mode différentiel ± 2 kV mode commun (symétrique)	La qualité du secteur électrique doit être identique à celle d'un environnement commercial et hospitalier conventionnel.
Creux de tension, coupures brèves et variations de tension sur les lignes d'alimentation selon IEC 61000-4-11	< 5 % UT (creux de >95 % de UT) pour un demi-cycle 40 % UT (creux de 60 % de UT) pour 5 cycles 70 % UT (creux de 30 % de UT) pour 25 cycles < 5 % UT (creux de >95 % de UT) pour 5 secondes	< 5 % UT (creux de >95 % de UT) pour un demi-cycle 40 % UT (creux de 60 % de UT) pour 5 cycles 70 % UT (creux de 30 % de UT) pour 25 cycles < 5 % UT (creux de >95 % de UT) pour 5 secondes	La qualité du secteur électrique doit être identique à celle d'un environnement commercial et hospitalier conventionnel. Si l'utilisateur de la lampe KaWe MASTERLIGHT HL / LED demande un fonctionnement continu du dispositif pendant les coupures d'alimentation, il est recommandé d'alimenter la lampe KaWe MASTERLIGHT HL / LED d'un système d'alimentation ininterrompue en courant ou d'une batterie.
Champ magnétique lors d'une fréquence du réseau (50/60 Hz) selon IEC 61000-4-8	3 A/m	30 A/m	Les champs magnétiques à la fréquence du réseau doivent atteindre les niveaux caractéristiques d'un environnement commercial et hospitalier conventionnel.

Remarque : UT est la tension alternative du réseau avant d'appliquer les niveaux d'essai.



Lignes de conduite et déclaration du fabricant – Immunité électromagnétique

La lampe KaWe MASTERLIGHTHL / LED doit être utilisée dans l'environnement électromagnétique spécifié ci-dessous.
Le client ou l'utilisateur de la lampe KaWe MASTERLIGHT HL / LED doit veiller à utiliser le dispositif dans cet environnement.

Tests d'immunité	Niveau IEC 60601	Niveau de conformité	Environnement électromagnétique – Lignes de conduite
<p>Perturbations conduites induites par les champs radioélectriques selon IEC 61000-4-6</p> <p>Champs électromagnétiques rayonnés aux fréquences radioélectriques selon IEC 61000-4-3</p>	<p>3 V de 150 kHz à 80 MHz</p> <p>3V/m de 80 MHz à 2,5 GHz</p>	<p>3 V</p> <p>3 V/m</p>	<p>Les appareils de communication RF portables et mobiles ne doivent pas être utilisés à proximité de la lampe KaWe MASTERLIGHT HL / LED y compris le câble ; il est important de respecter la distance d'isolement recommandée, calculée à partir de l'équation applicable à la fréquence du transmetteur.</p> <p>Distance d'isolement recommandée :</p> <p>$d = 1,2\sqrt{P}$</p> <p>$d = 1,2\sqrt{P}$ de 80 MHz à 800 MHz</p> <p>$d = 2,3\sqrt{P}$ de 800 MHz à 2,5 GHz</p> <p>où P est la puissance nominale du transmetteur en watts (W) selon les indications du fabricant du transmetteur et de la distance d'isolement recommandée en mètres (m).</p> <p>Les forces des champs produits par des transmetteurs RF fixes, établies par une étude électromagnétique du site ^a, doivent être inférieures au niveau de conformité ^b de toutes les fréquences.</p> <p> Des interférences peuvent apparaître au voisinage de tout équipement portant le symbole suivant.</p>

Remarque 1 : A 80 MHz et à 800 MHz, la plage de fréquences plus élevée s'applique.

Remarque 2 : Ces lignes de conduite ne s'appliquent pas à tous les cas. La propagation électromagnétique est affectée par l'absorption et la réflexion des structures, des objets et des personnes.

a : Les forces des champs émis par des transmetteurs fixes, tels que les relais de radiotéléphones (cellulaires/sans fil) et des radios mobiles, les radios amateurs, les émetteurs AM et FM et les téléviseurs ne peuvent pas être évaluées avec précision. Pour évaluer le rayonnement électromagnétique imputable aux transmetteurs RF fixes, une étude électromagnétique du site doit être envisagée. Si la force des champs mesurée sur le lieu d'utilisation de la lampe KaWe MASTERLIGHT HL / LED dépasse le niveau de conformité RF applicable ci-dessus, il est important de vérifier que la lampe KaWe MASTERLIGHT HL / LED fonctionne normalement. En cas d'anomalie, d'autres mesures devront être prises, comme la réorientation de l'appareil ou le choix d'un autre lieu pour la lampe KaWe MASTERLIGHT HL / LED.

b : Dans la plage de fréquences de 150 kHz à 80 MHz, la force des champs doit être inférieure à 3V/m.

Distances d'isolement recommandées entre les appareils de communication RF portables/mobiles et la lampe KaWe MASTERLIGHT HL / LED

La lampe KaWe MASTERLIGHT HL / LED doit être utilisée dans un environnement électromagnétique où les champs électromagnétiques aux fréquences radioélectriques sont contrôlés. Le client ou l'utilisateur de la lampe KaWe MASTERLIGHT HL / LED peut empêcher l'occurrence d'interférences électromagnétiques en respectant une distance minimale entre tout équipement de communication RF portable/mobile (transmetteurs) et la lampe KaWe MASTERLIGHT HL / LED – en fonction de la puissance de sortie de l'équipement de communication comme indiqué ci-dessous.

Puissance nominale du transmetteur (W)	Distance d'isolement en fonction de la fréquence du transmetteur (m)		
	de 150 kHz à 80 MHz $d = 1,2\sqrt{P}$	de 80 MHz à 800 MHz $d = 1,2\sqrt{P}$	de 800 MHz à 2,5 GHz $d = 2,3\sqrt{P}$
0,01	0,12	0,12	0,23
0,1	0,38	0,38	0,73
1	1,20	1,20	2,30
10	3,80	3,80	7,30
100	12	12	23,00

Pour les transmetteurs dont la puissance nominale maximale ne figure pas dans le tableau ci-dessus, la distance de protection d en mètres (m) recommandée peut être établie par l'équation applicable à la fréquence du transmetteur (colonne correspondante), où P est la puissance nominale maximale du transmetteur en watts (W), selon les indications du fabricant du transmetteur.

Remarque 1 : A 80 MHz et à 800 MHz, la plage de fréquences plus élevée s'applique.

Remarque 2 : Ces lignes de conduite ne s'appliquent pas à tous les cas. La propagation électromagnétique est affectée par l'absorption et la réflexion des structures, des objets et des personnes.



► 11. GARANTIE LÉGALE

Nous accordons une garantie légale de deux ans à compter de la date d'achat à condition que le maniement en soit conforme et le présent mode d'emploi suivi (sauf pour les ampoules/piles rechargeables). Pour toute information complémentaire ou les éventuelles réparations, consultez votre distributeur agréé.



Istruzioni per l'uso Lampada per studio medico KaWe MASTERLIGHT HL / LED

Sommario

1. Avvertenze di sicurezza	Pagina 32
2. Breve descrizione della lampada KaWe MASTERLIGHT HL / LED	Pagina 33
3. Volume di fornitura	Pagina 33
3.1 Indicazioni di montaggio: stativo con base a 5 ruote ..	Pagina 34
3.2 Indicazioni di montaggio: fissaggio al tavolo	Pagina 35
3.3 Indicazioni di montaggio: fissaggio alla parete	Pagina 36
3.4 Sostituzione del mezzo di illuminazione	Pagina 37
4. Pulizia	Pagina 37
4.1 Stativo	Pagina 37
4.2 Corpo lampada	Pagina 37
4.3 Lampada per studio medico	Pagina 37
5. Dati tecnici	Pagina 37
6. Manutenzione	Pagina 37
6.1 Lavori di manutenzione periodici	Pagina 37
7. Informazioni riguardo all'installazione elettrica	Pagina 38
7.1 Condizioni ambientali	Pagina 38
7.2 Informazioni importanti	Pagina 38
8. UDI-DI di base	Pagina 38
9. Smaltimento	Pagina 38
10. Tabelle: Informazioni riguardo alla compatibilità elettromagnetica	Pagina 38
11. Garanzia legale	Pagina 41

Egregio cliente, grazie per aver scelto un prodotto KaWe. I nostri prodotti si distinguono per la loro alta qualità e lunga durata. Questo prodotto KaWe è conforme alle disposizioni della Direttiva (UE) 2017/745 (direttiva europea sui dispositivi medici) e, in base a tale direttiva, è classificato come prodotto medico di classe I.

Si prega di leggere attentamente queste istruzioni per l'uso prima di utilizzare lo strumento e di seguire i consigli per la manutenzione.

I vantaggi della tecnica LED: una durata di vita di minimo 50.000 ore, un'elevata luminosità ed uno sviluppo di calore quasi impercettibile sia nell'area intorno alla testa del chirurgo che nella zona ferita. I vantaggi delle lampade di tipo alogeno finora impiegate dalla KaWe vengono mantenuti nei nuovi modelli: riproduzione fedele del colore, illuminazione mirata della zona ferita e facile posizionamento del corpo lampada.

► 1. AVVERTENZE DI SICUREZZA

Per la manipolazione della lampada vanno osservate le istruzioni per l'uso.

ATTENZIONE: Questa apparecchiatura non è concepita per l'utilizzo in ambienti a rischio di esplosione.

Si prega di leggere attentamente le istruzioni per l'uso per poter usufruire di tutti i vantaggi del sistema illuminotecnico e per evitare eventuali danni all'apparecchiatura.

La revisione della lampada e soprattutto i lavori di montaggio possono essere effettuati solamente dal personale tecnico.

Il produttore è responsabile della sicurezza della lampada solamente se le riparazioni e le modifiche vengono apportate dal produttore stesso o da esperti che garantiscano l'osservanza delle norme di sicurezza.

ATTENZIONE: È vietato apportare modifiche alla lampada!

Il produttore declina ogni responsabilità per danni a persone o a cose, se la lampada viene manipolata o impiegata in modo errato o per scopi non previsti. La KaWe MASTERLIGHT HL / LED non può essere combinata con altre apparecchiature.



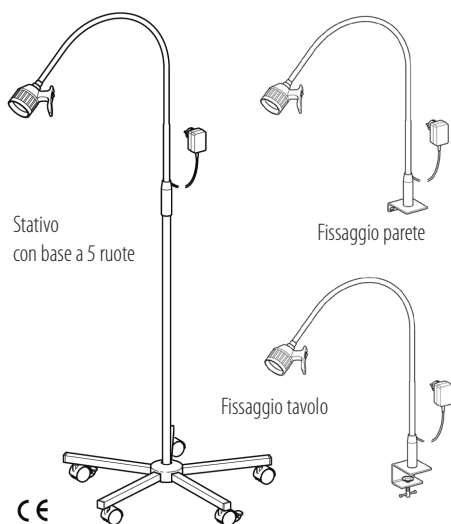







Prima di utilizzare la lampada accertarsi ogni volta che questa sia in stato perfetto.



Informazioni generali

- Tutte le lampade con stativo della KaWe vengono fornite complete di tutte le parti necessarie per il montaggio e l'allacciamento.
- Il fissaggio viene eseguito sullo stativo, su una parete o su un tavolo.
- Per rendere più sicuro l'imballaggio la base a cinque ruote dello stativo viene scomposta per la fornitura. Il tubo dello stativo è sempre assemblato come un'unica unità e dovrà essere solo montato sulla base servendosi della vite di fissaggio inferiore.
- La lampada viene sempre fornita con cavo di allacciamento integrato e spina con messa a terra.
- La presa di corrente utilizzata deve essere installata in ottemperanza ai requisiti della IEC e/o alla norma VDE 0100-710.

Significato dei simboli:

	Produttore
	Data di produzione
	Numero di lotto
	Atenersi al manual de uso
	Attenzione! Durante il montaggio e la sostituzione delle lampadine
	Limiti di temperatura
	Raccolta differenziata di apparecchiature elettriche ed elettroniche (RAEE)
	Adempimento delle direttive UE pertinenti
	Producto sanitario
	GOST-R Certificación de bienes de exportación importados a Rusia
	Limitación de la humedad del aire
	Classe di protezione II
	Producto frágil
	Il prodotto deve essere utilizzato in luogo asciutto
	Avvertenza: campo elettromagnetico

► 2. BREVE DESCRIZIONE DELLA LAMPADA KaWe MASTERLIGHT HL / LED

Uso previsto:

Le lampade sono state sviluppate per illuminare l'area di osservazione e di trattamento in ospedale o in ambulatorio medico. Le lampade sono state concepite per illuminare il campo di osservazione e di trattamento sul corpo del paziente con una luce "fredda" ad alto rendimento senza formazione di ombre.

Uso:

Le lampade diagnostiche possono essere utilizzate solamente dal personale tecnico e debitamente istruito!

Il gruppo di pazienti per i quali è indicato l'utilizzo del prodotto:

Tutti i gruppi di pazienti

it

► 3. VOLUME DI FORNITURA

- n. 1 blocco di montaggio stativo
- n. 2 razze tubolari con ruote con freno
- n. 3 razze tubolari con ruote senza freno
- n. 1 tubo stativo
- n. 1 cappuccio stativo
- n. 1 vite a testa cilindrica M8 con rosetta
- n. 1 chiave a forcella
- Corpo lampada con braccio
- Istruzioni per l'uso

Indicazioni per l'utilizzatore ed il paziente:

Tutti gli incidenti gravi legati al prodotto devono essere immediatamente segnalati al produttore e alle autorità competenti del rispettivo Stato membro in cui si trova l'utente e/o il paziente.

3.1 Indicazioni di montaggio: Stativo con base a 5 ruote

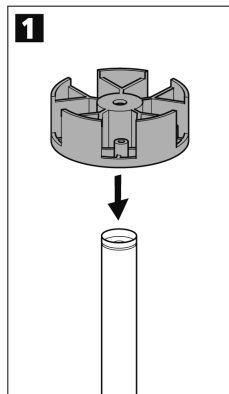
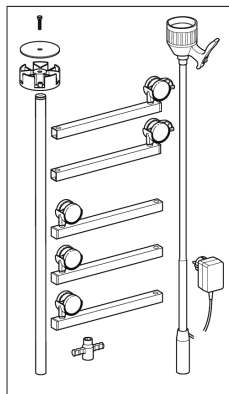
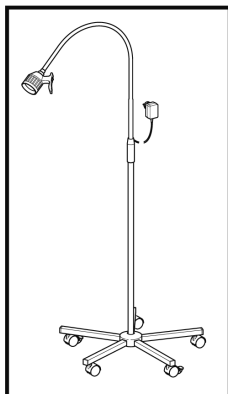

Parti da montare

1. Infilare il blocco.

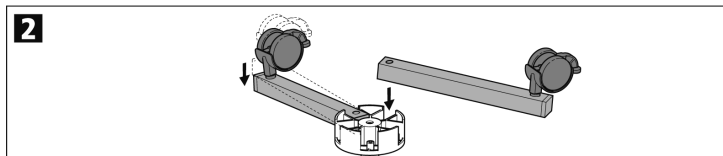

2. Agganciare due razze tubolari con ruote con freno una di fronte all'altra.

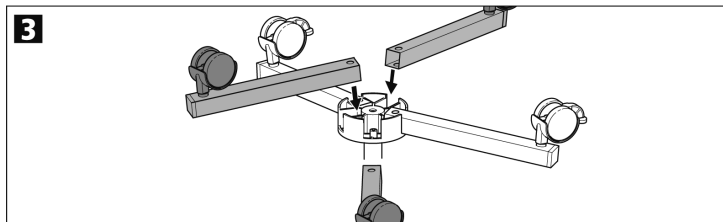

3. Agganciare tre razze tubolari con ruote senza freno.

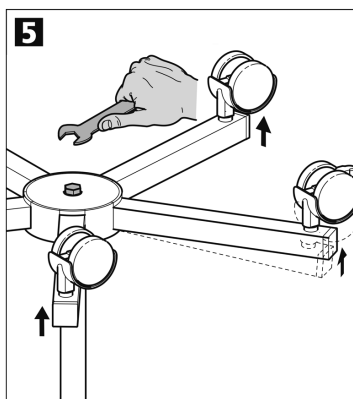
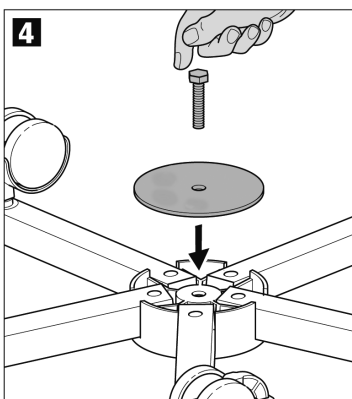

4. Avvitare la vite a testa esagonale.

5. Stringere la vite a testa esagonale.

it

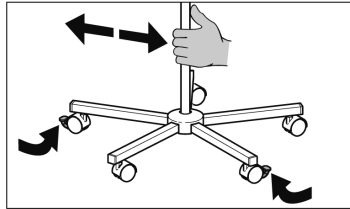
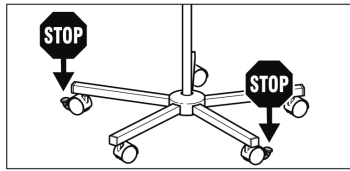
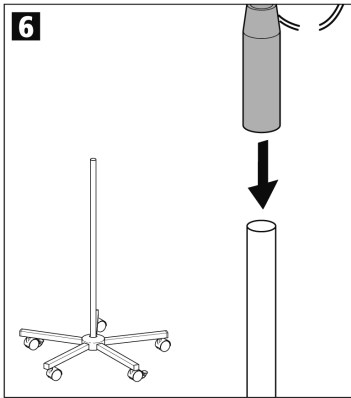

6. Spingere la parte superiore della lampada sulla base.

Bloccare le ruote con freno.
Sbloccare le ruote per gli spostamenti.



3.2 Indicazioni di montaggio: Fissaggio tavolo

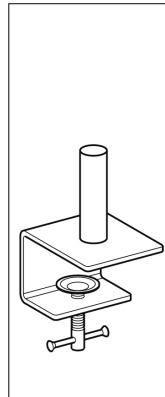
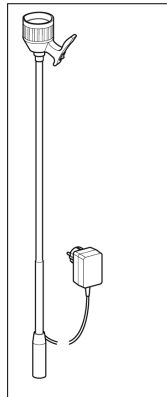
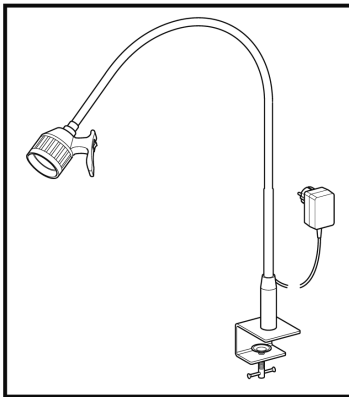

Parti da montare

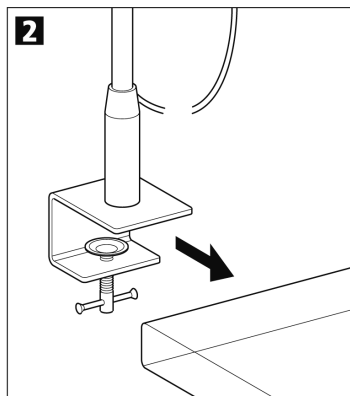
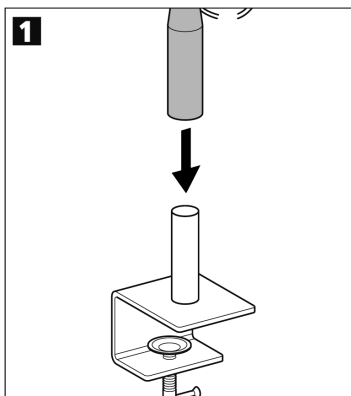

1. Spingere la parte superiore della lampada sul dispositivo di fissaggio da tavolo.

2. Avvitare la lampada al piano del tavolo.

3.3 Indicazioni di montaggio: Fissaggio parete

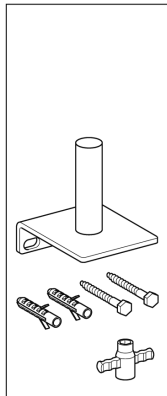
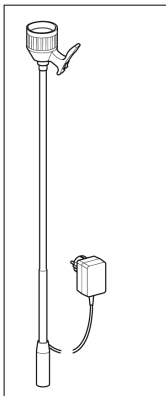
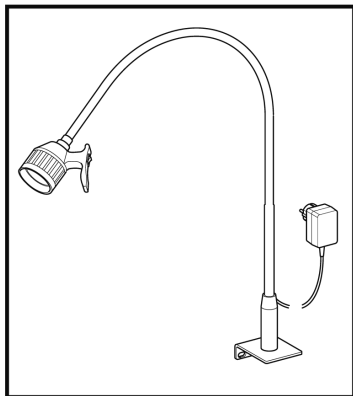

Parti da montare

it

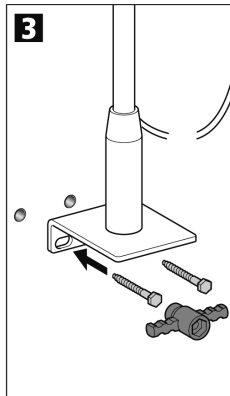
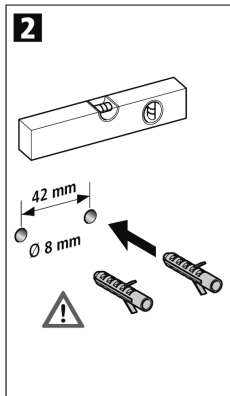
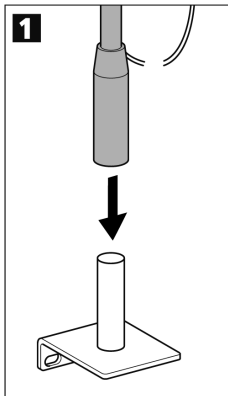

1. Spingere la parte superiore della lampada sul supporto angolare di parete.



2. Attenzione durante la foratura! Controllare se sulla parete si trovano condutture di corrente, gas e acqua.

3. Avvitare la lampada alla parete.

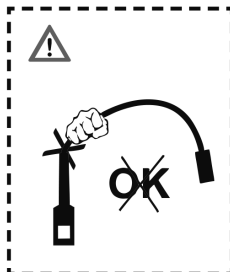
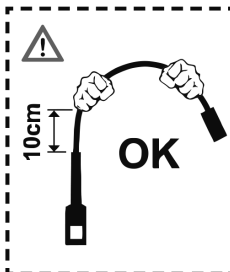
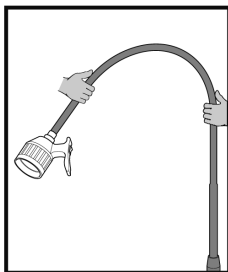

Orientare il raggio luminoso sempre e solo con entrambe le mani.

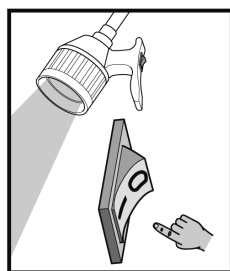
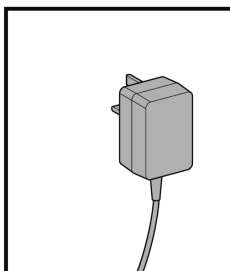
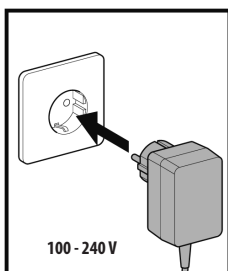

Collegamento di rete
(UE / GB)

Accendere - I -
Spegnerne - 0 -

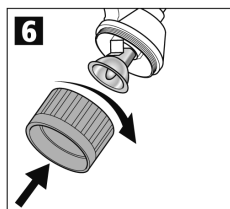
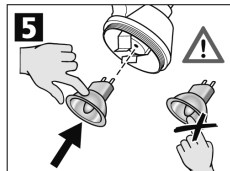
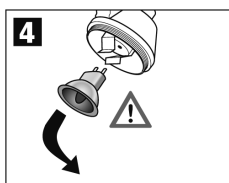
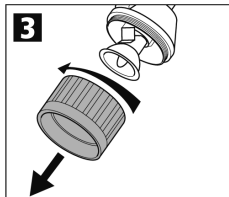
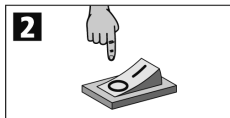
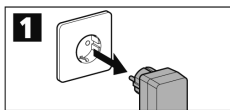
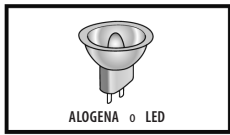

3.4 Sostituzione del mezzo di illuminazione

1. Staccare la spina.
2. Posizionare l'interruttore su - 0 -.
3. Svitare l'anello.



4. Staccare la lampadina difettosa solo dopo che si è raffreddata.
5. Inserire la lampadina.
6. Avvitare l'anello.

► 4. PULIZIA

Spegnere la lampadina prima di pulirla. Estrarre il connettore di rete e far raffreddare la testa della lampada.

4.1 Stativo: La superficie dello stativo si pulisce facilmente passando sopra un panno umido. Per la pulizia è possibile utilizzare detergenti comuni. Per un'ulteriore disinfezione si consigliano prodotti con soluzione d'acqua o **max. 20% di alcol**.

4.2 Corpo lampada: La superficie della lampada è pregiata. Per pulirla è sufficiente passarci sopra un panno umido utilizzando un detergente comune. Utilizzare solamente disinfettanti con **meno del 20% di alcol**.

4.3 Lampada per studio medico: 1. La lampada per studio medico è resistente a disinfettanti, sfregamento, urina e sangue. **2.** La lampada per studio medico va sfregata con un panno umido ed un apposito disinfettante per superfici a contenuto alcolico. **3.** Pulire le ruote sporche al fine di evitare carica statica. **4.** Non utilizzare sostanze contenenti acido.

► 5. DATI TECNICI:

Altezza massima: ca. 211 cm
 Area di rotazione parte superiore: ca. 82 cm
 Diametro piede di appoggio: ca. 70 cm
 Peso: ca. 4,7 kg
 Tensione di rete: 100 - 240 Volt
 Alogena: 12 V / 35 W / 5 A max.
 Durata di vita della lampadina alogena: ≥ 1.000 h
 LED: 12 V / 6,5 W / 0,8 A max.
 Durata di vita della lampadina LED: ca. 50.000h
 Angolo di irradiazione HL / LED: 8° / 24°
 Temperatura della luce ca.: HL: 3200K/LED: 4000K

Intensità luminosa (HL) ad una distanza di 30 cm 44.000 Lux
 Intensità luminosa (LED) ad una distanza di 30 cm 31.000 Lux
 Ampiezza campo luminoso
 (con distanza di lavoro pari a 0,5m) 100 mm

Osserva: I dati tecnici sottostanno a variazioni. Ciò vale soprattutto per quanto riguarda la durata di vita, la temperatura della luce e l'intensità luminosa. Il modello con stativo deve essere posizionato su superfici piane.

Avvertenza: la lampada diagnostica non è a tenuta d'acqua!
 Vanno osservati requisiti e prescrizioni degli organismi nazionali (norme e direttive) per l'igiene e la disinfezione.

► 6. MANUTENZIONE

In seguito ad un uso prolungato delle lampade KaWe MASTERLIGHT HL / LED, le viti vanno periodicamente riserrate. La manutenzione e revisione della lampada devono essere fatte al più tardi ogni due anni.

Avvertenza: durante l'uso, le lampade alogene possono diventare roventi! Per tutti gli interventi di manutenzione e controllo spegnere la lampada ed estrarre il connettore di rete. Assicurare la lampada contro il reinserimento.

6.1 Lavori di manutenzione periodici: Il sistema portante della lampada va sottoposto ogni due anni ai controlli / alle manutenzioni seguenti: **1.** fessure nelle parti in materiale sintetico **2.** controllo funzionale **3.** controllo della sicurezza elettrica **4.** controllo del sistema portante..



► 7. INFORMAZIONI RIGUARDO ALL'INSTALLAZIONE ELETTRICA

La lampada KaWe MASTERLIGHT HL / LED viene fornita con un alimentatore a spina come dotazione standard.

Attenzione! L'alimentatore a spina è un'apparechiatura della classe di protezione II.

7.1 Condizioni ambientali

	Funzionamento	
	Mln.	Max.
Temperatura	+10° C	+40° C*
Umidità relativa dell'aria	30 %	75 %
Pressione dell'aria	700 hPa	1060 hPa

*contattarci in caso di temperature superiori

Trasporto/Immagazzinamento

	Mln.	Max.
	Temperatura	-10° C
Umidità relativa dell'aria	30 %	75 %
Pressione dell'aria	700 hPa	1060 hPa

7.2 Avvertenze importanti

Quando vengono utilizzate contemporaneamente più lampade, è possibile che, a causa della sovrapposizione dei campi luminosi, l'intensità luminosa complessiva superi il valore di 1000 W/m². Ne consegue il rischio che si sviluppi calore elevato nel campo luminoso. Con la sovrapposizione dei campi luminosi di più lampade è possibile che si superino i valori limite per le radiazioni ultraviolette (< 400 nm) di 10 W/m². Se all'atto dell'installazione vengono collegate più lampade o apparecchiature, bisogna applicare l'articolo 16 della norma EN 60601-A1:2012 e verificare nel caso l'osservanza dei requisiti. Le lampade diagnostiche sottostanno a specifiche misure precauzionali relative alla compatibilità elettromagnetica. Il funzionamento delle lampade diagnostiche KaWe può essere pregiudicato da apparecchi radioelettrici portatili e mobili RF. (Si osservino le seguenti tabelle)

► 8. UDI-DI DI BASE

4030155KaWe10SK

► 9. SMALTIMENTO



Al termine della vita del prodotto i singoli componenti della lampada vanno smaltiti di regola. Fare attenzione ad una accurata separazione dei materiali. Le schede elettriche vanno portate in un apposito centro di riciclaggio per rifiuti elettrici. Il corpo lampada e gli altri componenti della lampada vanno smaltiti nei centri di raccolta in base ai singoli materiali.

it

► 10. TABELLE

Le lampade diagnostiche KaWe sottostanno a specifiche misure precauzionali relative alla compatibilità elettromagnetica e vanno installate nel rispetto delle istruzioni CEM che troverete nei documenti di accompagnamento. Il funzionamento delle lampade diagnostiche KaWe può essere pregiudicato da apparecchi radioelettrici portatili e mobili HF.

Direttive e dichiarazione del fabbricante – emissioni elettromagnetiche

La KaWe MASTERLIGHT HL / LED è prevista per l'uso negli ambienti elettromagnetici sotto indicati. Il cliente o l'utilizzatore del prodotto dovrebbe accertarsi che l'uso avvenga in un tale ambiente.

Misurazioni delle emissioni	Concor- danza	Direttive per ambiente elettromagnetico
Emissioni HF secondo CISPR 11	Grup- po 1	La KaWe MASTERLIGHT HL / LED utilizza energia HF esclusivamente per il suo funzionamento interno. Perciò le emissioni HF sono molto ridotte e difficilmente possono provocare interferenze con altre apparecchiature elettroniche presenti nelle vicinanze.
Emissioni HF secondo CISPR 11	Classe B	La KaWe MASTERLIGHT HL / LED è prevista per l'uso in tutti gli ambienti inclusi quelli domestici e quelli collegati direttamente ad una rete di erogazione pubblica che fornisce energia anche a edifici per uso domestico.
Emissioni armoniche secondo IEC 61000-3-2	Classe A	
Fluttuazioni di tensione/Flicker secondo IEC 61000-3-3	Con- forme	

Direttive e autocertificazione – Immunità a interferenze elettromagnetiche

La KaWe MASTERLIGHT HL / LED è prevista per l'uso negli ambienti elettromagnetici sotto indicati.

Il cliente o l'utilizzatore della KaWe MASTERLIGHT HL / LED dovrà accertarsi che la lampada funzioni in un tale ambiente.

Controlli dell'immunità	Livello per test IEC 60601	Livello di concordanza	Ambiente elettromagnetico – Direttive
Scariche elettrostatiche (ESD) secondo IEC 61000-4-2	± 6 kV scarica da contatto ± 8 kV scarica in aria	± 6 kV scarica da contatto ± 8 kV scarica in aria	I pavimenti dovrebbero essere in legno o cemento o con piastrelle in ceramica. Se il pavimento è coperto di materiale sintetico, l'umidità relativa dell'aria deve essere almeno del 30 %.
Disturbi transitori elettrici veloci/Bursts secondo IEC 61000-4-4	± 2 kV per linee di alimentazione rete ± 1 kV per linee in ingresso o in uscita => non applicabile	± 2 kV per linee di alimentazione rete ± 1 kV per linee in ingresso o in uscita => non applicabile	La qualità della tensione di alimentazione deve essere quella di un ambiente commerciale e ospedaliero tipico.
Sovratensioni (Surges) secondo IEC 61000-4-5	± 1 kV tensione in controfase ± 2 kV tensione sincrona (simmetrica)	± 1 kV tensione in controfase ± 2 kV tensione sincrona (simmetrica)	La qualità della tensione di alimentazione deve essere quella di un ambiente commerciale e ospedaliero tipico.
Cali, brevi interruzioni e variazioni della tensione nelle linee di alimentazione secondo IEC 61000-4-11	< 5 % UT per ½ ciclo (>95 % calo di UT) 40 % UT per 5 cicli (60 % calo di UT) 70 % UT per 25 cicli (30 % calo di UT) < 5 % UT per 5 secondi (>95 % calo di UT)	< 5 % UT per ½ ciclo (>95 % calo di UT) 40 % UT per 5 cicli (60 % calo di UT) 70 % UT per 25 cicli (30 % calo di UT) < 5 % UT per 5 secondi (>95 % calo di UT)	La qualità della tensione di alimentazione deve essere quella di un ambiente commerciale e ospedaliero tipico. Se l'utilizzatore della KaWe MASTERLIGHT HL / LED necessita di un funzionamento continuo anche in caso di interruzioni della corrente elettrica, si consiglia di collegare la KaWe MASTERLIGHT HL / LED a un gruppo di continuità (UPS) o una batteria.
Campo magnetico con frequenza di alimentazione (50/60 Hz) secondo IEC 61000-4-8	3 A/m	3 A/m	I campi magnetici della frequenza di rete devono essere quelli di un ambiente commerciale o ospedaliero tipico.

Annotazione: UT è la tensione alternata di rete prima dell'applicazione del livello per test.



Direttive e autocertificazione – Immunità a interferenze elettromagnetiche

La KaWe MASTERLIGHT HL / LED è prevista per l'uso negli ambienti elettromagnetici sotto indicati.

Il cliente o l'utilizzatore della KaWe MASTERLIGHT HL / LED dovrà accertarsi che la lampada funzioni in un tale ambiente.

Test di immunità	Livello per test IEC 60601	Livello di concordanza	Ambiente elettromagnetico – Direttive
Disturbi condotti, indotti da campi HF secondo IEC 61000-4-6	3V da 150 kHz a 80 MHz	3V	La distanza tra apparecchi radioelettrici portatili e mobili e la lampada KaWe MASTERLIGHT HL / LED incluse le condutture, non deve essere in nessun caso inferiore alla distanza di protezione consigliata, che va calcolata in base all'equazione corrispondente alla frequenza di trasmissione. Distanza di protezione consigliata: $d = 1,2\sqrt{P}$ $d = 1,2\sqrt{P}$ da 80 MHz a 800 MHz $d = 2,3\sqrt{P}$ da 800 MHz a 2,5 GHz
Disturbi irradiati da campi HF secondo IEC 61000-4-3	3V/m da 80 MHz a 2,5 GHz	3V/m	Con P quale potenza nominale del trasmettitore in Watt (W) secondo le indicazioni del produttore del trasmettitore e d quale distanza di protezione consigliata in metri (m). Per tutte le frequenze l'intensità di campo di radio-trasmettitori fissi dovrebbe essere inferiore al livello di concordanza in base ad una verifica sul luogo ^{a, b}



Disturbi sono possibili nei dintorni di apparecchiature che portano il simbolo seguente.

Annotazione 1: A 80 MHz e 800 MHz vale il campo di frequenza rispettivamente maggiore.

Annotazione 2: È possibile che queste direttive non siano applicabili in tutti i casi. La propagazione di grandezze elettromagnetiche viene influenzata da assorbimenti e riflessi di edifici, oggetti e persone.

a: teoricamente non è possibile predeterminare esattamente l'intensità di campo di trasmettitori fissi come ad es. stazioni base di cellulari e altri apparecchi radioelettrici mobili per comunicazione via terra, stazioni per radioamatori, radioemittenti AM e FM nonché trasmettitori televisivi. Per rilevare l'ambiente elettromagnetico relativo ai trasmettitori fissi si dovrebbe tenere in considerazione un'analisi del luogo. Nel caso in cui l'intensità di campo rilevata sul luogo in cui viene usata la lampada KaWe MASTERLIGHT HL / LED superasse i livelli di concordanza sopradetti, la KaWe HL / LED dovrebbe essere tenuta in osservazione per garantire un funzionamento secondo le norme. Osservando caratteristiche non usuali potrebbero rendersi necessarie ulteriori misure come p.e. modificare l'allineamento o la posizione della lampada KaWe MASTERLIGHT HL / LED.

b: Nel campo di frequenza da 150 kHz a 80 MHz l'intensità di campo dovrebbe essere inferiore a 3V/m.

Distanze di protezione consigliate tra dispositivi di radiocomunicazione HF portatili e mobili e la KaWe MASTERLIGHT HL / LED

La KaWe MASTERLIGHT HL / LED è prevista per una zona in un'ambiente elettromagnetico in cui vengono controllati i disturbi irradiati da campi HF. Il cliente o l'utilizzatore della KaWe MASTERLIGHT HL / LED può aiutare a evitare disturbi elettromagnetici rispettando, come di seguito indicato, la distanza minima tra dispositivi di radiocomunicazione HF portatili e mobili (trasmettitori) e la KaWe MASTERLIGHT HL / LED – in funzione alla potenza di uscita del dispositivo di radiocomunicazione stesso.

Potenza nominale del trasmettitore (W)	Distanza di protezione in funzione della frequenza di trasmissione (m)		
	da 150 kHz a 80 MHz $d = 1,2\sqrt{P}$	da 80 MHz a 800 MHz $d = 1,2\sqrt{P}$	da 800 MHz a 2,5 GHz $d = 2,3\sqrt{P}$
0,01	0,12	0,12	0,23
0,1	0,38	0,38	0,73
1	1,20	1,20	2,30
10	3,80	3,80	7,30
100	12,00	12,00	23,00

Per trasmettitori la cui massima potenza nominale non è indicata nella tabella sopra riportata, la distanza di protezione consigliata d in metri (m) può essere rilevata mediante l'equazione appartenente alla corrispettiva colonna essendo P la massima potenza nominale del trasmettitore in Watt (W) in base alle indicazioni del produttore del trasmettitore.

Annotazione 1: A 80 MHz e 800 MHz vale il campo di frequenza rispettivamente maggiore.

Annotazione 2: È possibile che queste direttive non siano applicabili in tutti i casi. La propagazione di grandezze elettromagnetiche viene influenzata da assorbimenti e riflessi di edifici, oggetti e persone.



► 11. GARANZIA LEGALE

Previ l'utilizzo regolamentare e l'osservanza delle nostre istruzioni per l'uso, il prodotto è coperto da garanzia legale per due anni, a partire dalla data di acquisto dello stesso (ad eccezione di batterie ricaricabili e lampadine). In caso di ulteriori domande o eventuali riparazioni si prega di rivolgersi al proprio rivenditore di fiducia.



Instrucciones de empleo

Lámpara de exploración KaWe MASTERLIGHT HL / LED

Contenido

1.	Instrucciones de seguridad	página 42
2.	Descripción resumida de la lámpara KaWe MASTERLIGHT HL / LED	página 43
3.	Volumen de suministro	página 43
3.1	Instrucciones de montaje: Base de 5 tubos	página 44
3.2	Instrucciones de montaje: Fijación en la mesa	página 45
3.3	Instrucciones de montaje: Fijación en la pared	página 46
3.4	Cambiar la luminaria	página 47
4.	Limpieza	página 47
4.1	Pie	página 47
4.2	Cuerpo de lámpara	página 47
4.3	Lámpara de exploración	página 47
5.	Datos técnicos	página 47
6.	Mantenimiento	página 47
6.1	Trabajos de mantenimiento constante	página 47
7.	Indicaciones referentes a la instalación eléctrica	página 48
7.1	Condiciones de entorno	página 48
7.2	Indicaciones importantes	página 48
8.	UDI-DI básico	página 48
9.	Eliminación	página 48
10.	Tablas: Informaciones sobre la compatibilidad electromagnética	página 48
11.	Garantía legal	página 51

Estimado cliente: le agradecemos la confianza que ha depositado en nosotros al elegir uno de los productos KaWe. Nuestros productos se caracterizan por su alta calidad y su larga vida útil. Las lámparas cumplen las disposiciones del Reglamento (UE) 2017/745 (Reglamento Europeo sobre Aparatos Sanitarios), de acuerdo con el cual, pertenece a la clase I de productos sanitarios.



Por favor, lea con atención las presentes instrucciones de empleo en su totalidad y siga las indicaciones referentes al cuidado del aparato antes de utilizarlo.

Las ventajas de la tecnología LED: Las ventajas de la tecnología LED: una vida útil de por lo menos 50.000 horas, una luminosidad alta y un desarrollo de calor casi imperceptible, tanto en el sector de la cabeza del cirujano como también en el área de operación. Se han mantenido las ventajas de la tecnología luminosa actual con lámparas halógenas utilizada por KaWe: reproducción natural de colores, iluminación exacta del área de operación y un posicionamiento fácil del cuerpo de lámpara.



1. INDICACIONES DE SEGURIDAD

Para el manejo correcto de la lámpara debe observarse el manual de uso.

ATENCIÓN: Este aparato no ha sido desarrollado para ser usado en atmósferas potencialmente explosivas.

Leer cuidadosamente el manual de empleo para poder usar todas las ventajas del sistema de iluminación y para evitar posibles daños en el aparato.

La reparación de la lámpara y los trabajos de montaje especiales sólo se realizarán por personal calificado.

La seguridad de la lámpara sólo puede ser garantizada por el productor si las reparaciones y modificaciones son realizadas por este mismo o por una empresa que garantice el cumplimiento de las normas de seguridad.

ATENCIÓN: ¡Se prohíbe modificar la lámpara!

En caso de que la lámpara se destine a otros fines o si se somete a un manejo incorrecto, el fabricante no asume responsabilidad alguna por daños materiales o lesiones personales. La lámpara KaWe MASTERLIGHT HL / LED no está apropiada para ser combinada con otros aparatos.



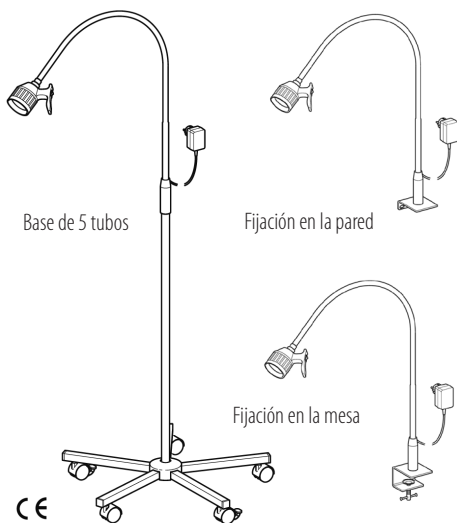



Asegurarse antes de cada uso que la lámpara esté en perfecto estado técnico.



Indicaciones generales

- Todas las lámparas de pie de KaWe son entregadas con todas las piezas necesarias para el montaje y la conexión.
- La fijación se realiza en la base, en la pared o en la mesa.
- Por motivos de embalaje se entregarán los cinco tubos del pie en unidades. El asta siempre está montada como unidad y sólo necesita ser montada en la base con el tornillo de fijación inferior.
- La lámpara es entregada con cable de conexión integrado y con enchufe con toma de tierra.
- El enchufe necesario debe ser instalado según los requerimientos de la norma alemana VDE 0100-710 o la norma internacional IEC correspondiente.

Explicación de los símbolos:

	Fabricante
	Fecha de fabricación
	Código de lote
	Atenerse al manual de uso
	¡Atención! Durante el montaje y al cambiar la bombilla
	Límite de temperatura
	Recogida selectiva de aparatos eléctricos y electrónicos
	Respecto de las directivas CE pertinentes
	Producto sanitario
	GOST-R Certificación de bienes de exportación importados a Rusia
	Limitación de la humedad del aire
	Clase de protección II
	Producto frágil
	Proteger contra la humedad
	¡Atención! Campo electromagnético

► 2. DESCRIPCIÓN RESUMIDA DE LA LÁMPARA KaWe MASTERLIGHT HL / LED

Empleo conforme a la finalidad prevista:

Las lámparas fueron desarrolladas para iluminar el área de explotación y de tratamiento en hospitales o consultorios médicos. Iluminan el área de trabajo y el cuerpo del paciente con una iluminación «fría» de alto rendimiento libre de sombras.

Uso:

¡Solo el personal cualificado e instruido está autorizado para poner en servicio este producto!

Grupo de pacientes que tiene indicado su uso:

Todos los grupos de pacientes

► 3. VOLUMEN DE SUMINISTRO

- 1 bloque de montaje del pie
- 2 barras de apoyo con ruedas con freno
- 3 barras de apoyo con ruedas sin freno
- 1 asta
- 1 tapa de pie
- 1 tornillo cilíndrico M8 con arandela
- 1 llave de boca
- Cuerpo de lámpara con brazo
- Instrucciones de empleo

Instrucciones para el usuario y el paciente:

Todos los incidentes graves relacionados con el producto deben informarse inmediatamente al fabricante y a las autoridades competentes del Estado miembro correspondiente en el que se encuentre el usuario y/o el paciente.



3.1 Instrucciones de montaje: Base de 5 tubos

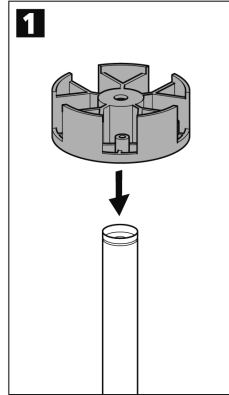
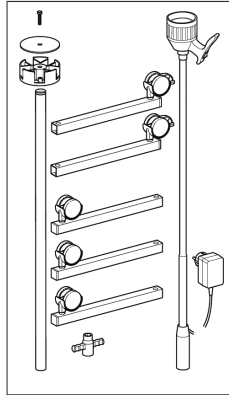
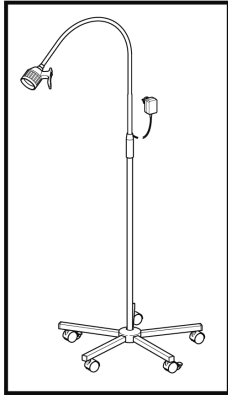

Piezas

1. Insertar el bloque.

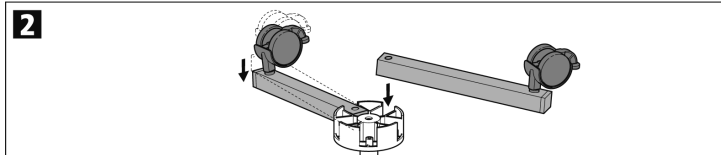

2. Colgar las dos barras de apoyo, cuyas ruedas tienen freno, en posiciones opuestas.

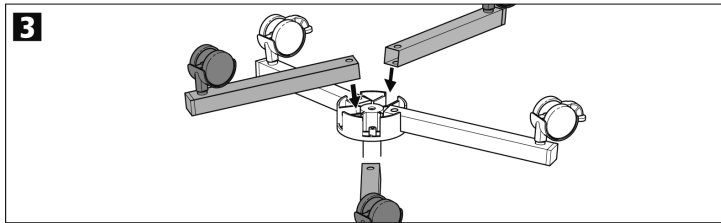

3. Colgar las tres barras de apoyo cuyas ruedas no tienen freno.

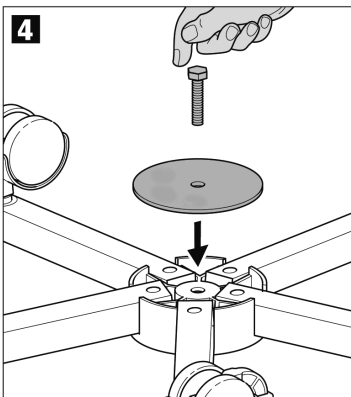

4. Enroscar el tornillo de cabeza hexagonal.

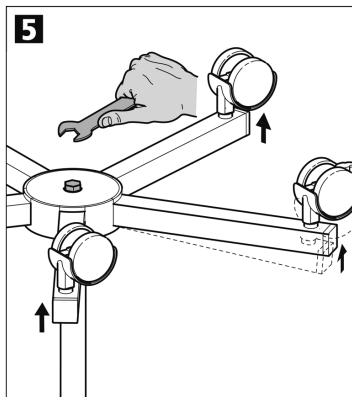

5. Apretar el tornillo de cabeza hexagonal.

es

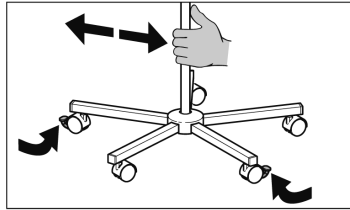
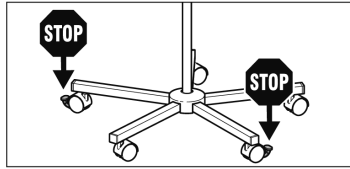
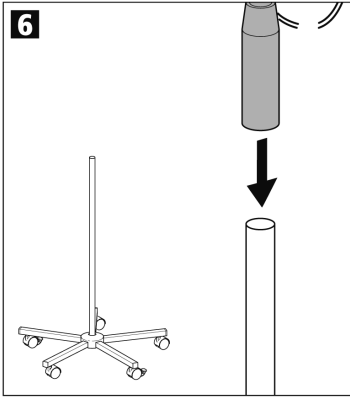

6. Deslizar la parte superior de la lámpara de exploración sobre la parte inferior.

Frenar las ruedas. Quitar el freno de las ruedas para mover el soporte.

3.2 Instrucciones de montaje: Fijación en la mesa

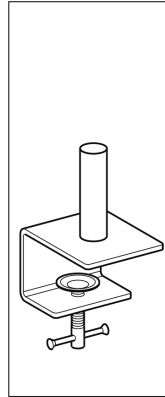
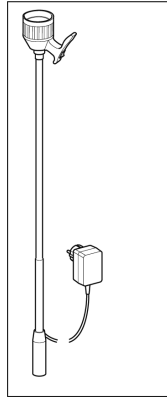
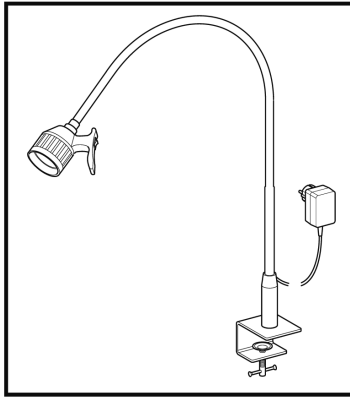

Piezas

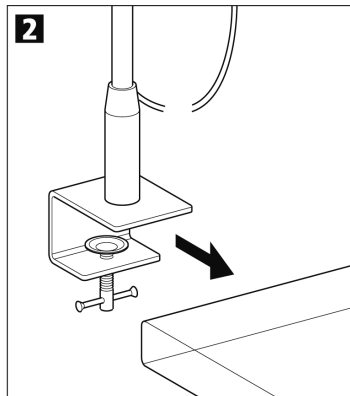
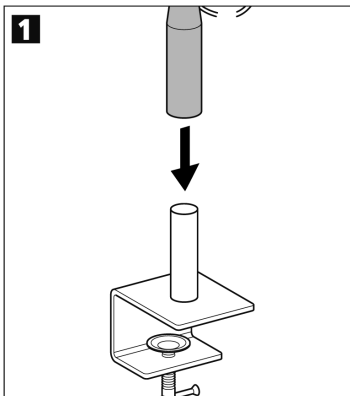

1. Deslizar la parte superior de la lámpara de exploración sobre la pinza para fijación en la mesa.

2. Atornillar la lámpara de exploración en la placa de la mesa.

3.3 Instrucciones de montaje: Fijación en la pared

Piezas

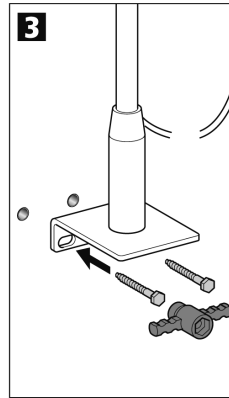
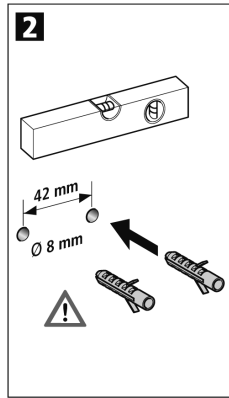
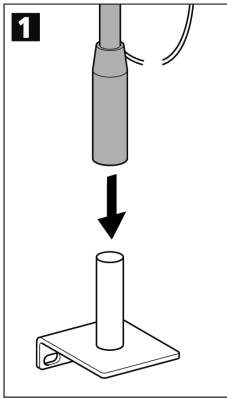
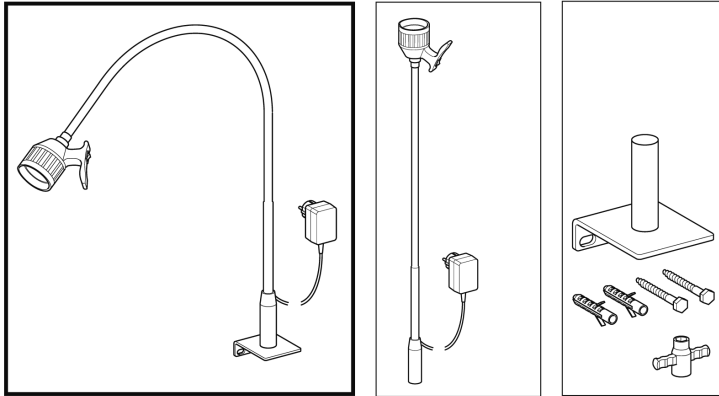

1. Deslizar la parte superior de la lámpara de exploración sobre la escuadra para fijación mural.



2. Cuidado al perforar los agujeros! Compruebe que por la pared no pasan cables ni tuberías de agua ni de gas.

3. Atornillar la lámpara de exploración en la pared.

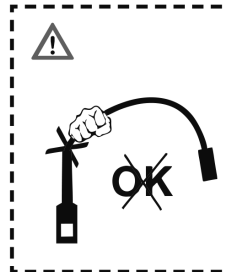
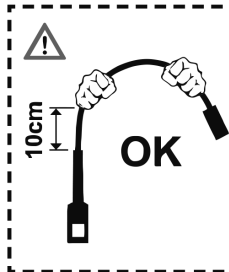
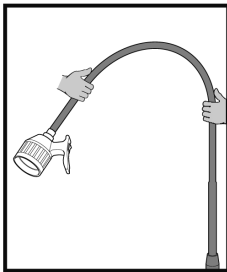

Ajustar el sentido de la luz usando siempre las dos manos.

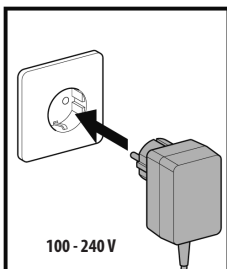

100 - 240 V

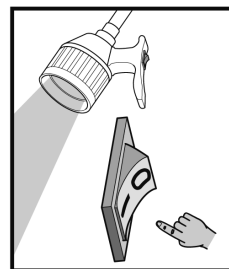
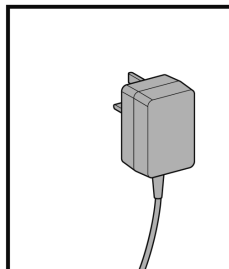

Conexión a la red (UE / GB)

ENCENDER - I -
APAGAR - 0 -

es

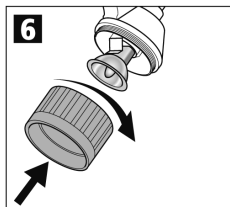
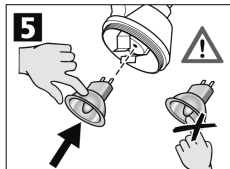
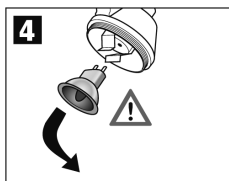
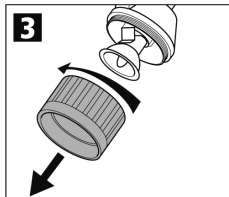
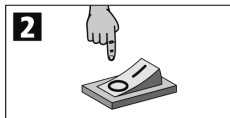
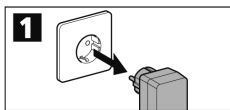

3.4 Cambiar la luminaria

1. Desconectar el enchufe.
2. Poner el interruptor a - 0 -.
3. Desatornillar el anillo.



4. Dejar enfriar el foco y sólo entonces retirarlo.
5. Conectar el foco.
6. Atornillar el anillo.

► 4. LIMPIEZA

Apagar la lámpara antes de la limpieza. Sacar la clavija y dejar enfriar el cabezal de la lámpara.

4.1 Pie: La superficie del pie puede ser limpiada fácilmente con un paño húmedo. Puede utilizar para ello los agentes de limpieza normales. Para una posible desinfección se sugiere agentes que han sido disueltos en agua o a lo sumo en **20% de alcohol (máx.)**.

4.2 Cuerpo de lámpara: La lámpara está provista con una superficie de alta calidad. La superficie de la lámpara puede ser limpiada fácilmente con un paño húmedo con un agente de limpieza normal. Utilizar únicamente material desinfectante con **menos de 20% de alcohol**.

4.3 Lámpara de exploración: **1.** La lámpara de exploración es resistente a las sustancias desinfectantes, la abrasión, la orina y la sangre. **2.** Limpiar la lámpara de exploración frotando con un paño húmedo y desinfectante de superficies con alcohol. **3.** Limpiar las ruedas, cuando estén sucias, para evitar que se forme electricidad estática. **4.** No emplear agentes o medios con contenido ácido.

► 5. DATOS TÉCNICOS:

Altura máxima: 211 cm aprox.
 Alcance de giro de la parte superior: 82 cm aprox.
 Diámetro del conjunto de los pies de apoyo: 70 cm aprox.
 Peso: aprox. 4,7 kg
 Tensión de alimentación: 100 - 240 V
 Halógeno: 12 V / 35 W / 5 A max.
 Vida útil de la bombilla halógena: ≥ 1.000 h
 LED: 12 V / 6,5W / 0,8 A max.
 Vida útil de la bombilla LED: aprox. 50.000h
 Ángulo de radiación HL / LED: 8° / 24°
 Temperatura de la luz aprox.: HL: 3200K/LED: 4000K
 Intensidad luminosa (HL) en una distancia de 30 cm 44.000 lux
 Intensidad luminosa (LED) en una distancia de 30 cm 31.000 lux

Tamaño del área luminosa
 (con una distancia de trabajo de 0,5 m) 100 mm

Nota: Los datos técnicos están sometidos a cambios. Esto vale sobre todo para el tiempo de vida útil, la temperatura de la luz y la intensidad luminosa. El modelo con base rotante debe ser colocado sobre superficies planas.

Nota: La lámpara para exploración médica no está protegida a prueba de aguas! Es indispensable observar las exigencias de los gremios nacionales (normas y directrices) en cuanto a la higiene y desinfección.

► 6. MANTENIMIENTO

Después de cierto tiempo de utilización, los tornillos de la lámpara KaWe MASTERLIGHT HL / LED deben ser reapretados. A más tardar cada dos años deben realizarse el mantenimiento y el control de la lámpara.

Nota: Si se utiliza una bombilla halógena, la lámpara puede calentarse! Al realizar trabajos de mantenimiento y de control desconectar la lámpara y desconectar la fuente de alimentación. Asegurar la lámpara contra una posible reconexión.

6.1 Trabajos de mantenimiento constante: Cada dos años debe someterse el sistema portante de la lámpara a las siguientes pruebas / mantenimientos: **1.** Fisuras en piezas de plástico **2.** Comprobación del buen funcionamiento **3.** Control de la seguridad eléctrica **4.** Control del sistema portante.



► 7. INDICACIONES REFERENTES A LA INSTALACIÓN ELÉCTRICA

La lámpara KaWe MASTERLIGHT HL / LED se suministra con una fuente de alimentación enchufable estándar.

¡Atención! La fuente de alimentación enchufable corresponde a un aparato de la clase de protección II.

7.1 Condiciones de entorno

	Funcionamiento	
	Mín.	Máx.
Temperatura	+10° C	+40° C*
Humedad relativa del aire	30 %	75 %
Presión atmosférica	700 hPa	1060 hPa

*para mayores temperaturas, sírvanse consultarnos

	Transporte/almacenamiento	
	Mín.	Máx.
Temperatura	-10° C	+50° C
Humedad relativa del aire	30 %	75 %
Presión atmosférica	700 hPa	1060 hPa

7.2 Indicaciones importantes

Al encender varias lámparas al mismo tiempo es posible que la irradiación total sobrepase el valor de 1000 W/m² debido al traslape de campos de iluminación. Por lo tanto, podría existir el riesgo de calor excesivo en el campo luminoso. Por el traslape de los campos luminosos de varias lámparas es posible que se sobrepase el valor límite de radiación UV (< 400 nm) de 10 W/m². Si lámparas o aparatos adicionales son conectados durante la instalación a una misma red, es necesario aplicar el apartado 16 de la norma EN 60601-A1:2012 y comprobar en caso dado el cumplimiento de las exigencias. En cuanto a la compatibilidad electromagnética (CEM), se deben tomar precauciones particulares para las lámparas de exploración médica KaWe. Los equipos de comunicaciones por RF portátiles y móviles pueden afectar el funcionamiento de la lámpara para exploración médica KaWe. (ver las siguientes tablas)

► 8. UDI-DI BÁSICO

4030155KaWe10SK

► 9. ELIMINACIÓN



Al final de la vida útil del producto deben eliminarse correctamente los componentes de la lámpara. Observar que se separe cuidadosamente el material. Las placas conductoras eléctricas deben ser eliminadas en un reciclaje respectivo. El bastidor de la lámpara y los componentes restantes de ésta deben ser eliminados según el material respectivo.



► 10. TABLAS

Las lámparas para exploración médica KaWe están sujetas a medidas especiales de precaución en cuanto a la compatibilidad electromagnética y deberán ser instaladas conforme a las instrucciones CEM especificadas en los documentos adjuntos. Los equipos de comunicaciones por RF portátiles y móviles pueden afectar el funcionamiento de la lámpara para exploración médica KaWe.

Directrices y declaración del fabricante – emisiones electromagnéticas		
La lámpara KaWe MASTERLIGHT HL / LED está diseñada para su funcionamiento en el entorno electromagnético especificado a continuación. El cliente o usuario del aparato debe asegurarse de que se utiliza en un entorno de este tipo.		
Prueba de emisiones	Conformidad legal	Entorno electromagnético – guía
Emisiones de RF según CISPR 11	Grupo 1	La lámpara KaWe MASTERLIGHT HL / LED sólo emplea energía de RF para su funcionamiento interno. Por consiguiente, sus emisiones de RF son muy bajas y no suelen causar interferencias en equipos electrónicos próximos.
Emisiones de RF según CISPR 11	Clase B	La lámpara KaWe MASTERLIGHT HL / LED puede utilizarse en cualquier lugar, incluidas viviendas, así como en establecimientos directamente conectados a la red pública de suministro eléctrico de bajo voltaje que abastece a edificios de viviendas.
Radiaciones armónicas según IEC 61000-3-2	Clase A	
Fluctuaciones de tensión / parpadeo según IEC 61000-3-3	Conforme	

Guía y declaración del fabricante – Inmunidad electromagnética

La lámpara KaWe MASTERLIGHT HL / LED está diseñada para utilizarse en el entorno electromagnético que se especifica a continuación. El cliente o usuario de la lámpara KaWe MASTERLIGHT HL / LED debe asegurarse de que se emplea en dicho entorno.

Pruebas de inmunidad	Nivel de prueba IEC 60601	Nivel de cumplimiento	Entorno electromagnético – Guía
Descarga electrostática (ESD) según IEC 61000-4-2	± 6 kV en contacto ± 8 kV por aire	± 6 kV en contacto ± 8 kV por aire	Los suelos han de ser de madera, hormigón o baldosa de cerámica. Si el suelo es sintético, el valor de la humedad relativa ha de ser del 30% como mínimo.
Ráfaga transitoria rápida eléctrica según IEC 61000-4-4	± 2 kV para líneas de alimentación eléctrica ± 1 kV para líneas de entrada y de salida => no aplicable	± 2 kV para líneas de alimentación eléctrica ± 1 kV para líneas de entrada y de salida => no aplicable	La calidad de la red de energía eléctrica debe ser equivalente a la existente en un comercio y hospital.
Impulsos de tensión (surges) según IEC 61000-4-5	± 1 kV tensión simétrica ± 2 kV tensión en modo (común)	± 1 kV tensión simétrica ± 2 kV tensión en modo (común)	La calidad de la red de energía eléctrica debe ser equivalente a la existente en un comercio y hospital.
Caída de tensión, interrupciones breves y variaciones de tensión en líneas de alimentación eléctrica según IEC 61000-4-11	< 5 % UT (>95 % de hueco de UT) durante medio ciclo 40 % UT (60 % de hueco de UT) durante 5 ciclos 70 % UT (30 % de hueco de UT) durante 25 ciclos < 5 % UT (>95 % de hueco de UT) durante 5 segundos	< 5 % UT (>95 % de hueco de UT) durante medio ciclo 40 % UT (60 % de hueco de UT) durante 5 ciclos 70 % UT (30 % de hueco de UT) durante 25 ciclos < 5 % UT (>95 % de hueco de UT) durante 5 segundos	La calidad de la red de energía eléctrica debe ser equivalente a la existente en un comercio y hospital. Si el usuario de la lámpara KaWe MASTERLIGHT HL / LED requiere su funcionamiento continuo durante las interrupciones de la red de energía eléctrica, se recomienda alimentar la lámpara MASTERLIGHT HL / LED con un sistema de energía ininterrumpida o con una batería.
Campo magnético durante una frecuencia de alimentación (50/60 Hz) según IEC 61000-4-8	3 A/m	30 A/m	Los campos magnéticos de la frecuencia de la red eléctrica deben ser equivalentes a los existentes en un comercio y hospital.

Nota: UT es la tensión alterna de la red antes de aplicar los niveles de prueba.



Guía y declaración del fabricante – Inmunidad electromagnética

La lámpara KaWe MASTERLIGHT HL / LED está diseñada para utilizarse en el entorno electromagnético que se especifica a continuación. El cliente o usuario de la lámpara KaWe MASTERLIGHT HL / LED debe asegurarse de que se emplea en dicho entorno.

Pruebas de inmunidad	Nivel de prueba IEC 60601	Nivel de cumplimiento	Entorno electromagnético – Guía
RF conducida según IEC 61000-4-6	3V 150 kHz a 80 MHz	3V	<p>Los equipos de comunicaciones por RF móviles y portátiles deben utilizarse a una distancia de la lámpara KaWe MASTERLIGHT HL / LED y de su cable que no sea inferior a la distancia recomendada y calculada a partir de la ecuación aplicable a la frecuencia del transmisor. Distancia de separación recomendada:</p> $d = 1,2\sqrt{P}$ $d = 1,2\sqrt{P} \text{ para } 80 \text{ MHz a } 800 \text{ MHz}$ $d = 2,3\sqrt{P} \text{ para } 800 \text{ MHz a } 2,5 \text{ GHz}$ <p>donde P es el valor nominal de la potencia del transmisor en vatios (W) según el fabricante del transmisor y d es la distancia de separación recomendada en metros (m).</p> <p>La fuerza de campo desde transmisores de RF fijos, tal y como se determina en la evaluación electromagnética del lugar ^a, debe ser inferior al nivel de cumplimiento en todas las frecuencias. ^b</p> <p> Pueden producirse interferencias en proximidad de equipos marcados con el símbolo siguiente.</p>
RF radiada según IEC 61000-4-3	3V/m de 80 MHz a 2,5 GHz	3V/m	

Nota 1: A 80 MHz y 800 MHz se aplica el intervalo de frecuencia superior.

Nota 2: Estas pautas pueden no ser aplicables en todas las situaciones. La propagación electromagnética se ve afectada por la absorción y reflexión de estructuras, objetos y personas.

a: La fuerza de los campos creados por transmisores fijos, como estaciones base de telefonía por radio y estaciones terrestres móviles, radioaficionados, emisoras de radio AM y FM y emisoras de televisión no se puede predecir teóricamente con precisión. Para valorar el entorno electromagnético debido a los transmisores de RF fijos, se debe considerar la evaluación del emplazamiento en cuestión. Si la intensidad de campo medida en el lugar en que se utiliza la lámpara KaWe MASTERLIGHT HL / LED supera el nivel de conformidad arriba mencionado, se deberá verificar que la lámpara KaWe MASTERLIGHT HL / LED funciona correctamente. Si se observa un rendimiento anormal, podrán ser necesarias medidas adicionales, como cambiar la orientación o la posición de la lámpara KaWe MASTERLIGHT HL / LED.

b: En el intervalo de frecuencia comprendido entre 150 kHz y 80 MHz, la intensidad de campo debe ser inferior a 3 V/m.

Distancias de separación recomendadas entre equipos de comunicaciones portátiles y móviles y la lámpara KaWe MASTERLIGHT HL / LED

La lámpara KaWe MASTERLIGHT HL / LED está diseñada para utilizarse en el entorno electromagnético donde se controla la perturbación de la radiofrecuencia. El cliente o el usuario de la lámpara KaWe MASTERLIGHT HL / LED puede evitar las interferencias electromagnéticas respetando la distancia mínima entre los equipos de comunicación de RF portátiles y móviles (transmisores) y la lámpara KaWe MASTERLIGHT HL / LED, como se recomienda abajo, de acuerdo a la potencia nominal de salida del equipo de comunicación.

Potencia nominal del transmisor (W)	Distancia de separación según la frecuencia del transmisor en metros (m)		
	de 150 kHz a 80 MHz $d = 1,2\sqrt{P}$	80 MHz a 800 MHz $d = 1,2\sqrt{P}$	800 MHz a 2,5 GHz $d = 2,3\sqrt{P}$
0,01	0,12	0,12	0,23
0,1	0,38	0,38	0,73
1	1,20	1,20	2,30
10	3,80	3,80	7,30
100	12,00	12,00	23,00

Para transmisores cuya potencia nominal máxima no se indica aquí, la distancia de separación recomendada d en metros (m) se puede determinar utilizando la ecuación equivalente a la frecuencia del transmisor, siendo P la potencia nominal máxima del transmisor en vatios (W) indicada por su fabricante.

Nota 1: A 80 MHz y 800 MHz se aplica el intervalo de frecuencia superior.

Nota 2: Estas pautas pueden no ser aplicables en todas las situaciones. La propagación electromagnética se ve afectada por la absorción y reflexión de estructuras, objetos y personas.



► 11. GARANTÍA LEGAL

Garantía legal de dos años a partir de la fecha de compra, siempre y cuando el producto sea utilizado correctamente y el usuario se atenga a nuestras instrucciones de empleo (a excepción de las bombillas y pilas recargables). En caso de dudas o posibles reparaciones, diríjase a su distribuidor especializado.

Índice

1. Conselhos de segurança	página 52
2. Descrição resumida do foco KaWe MASTERLIGHT HL / LED	página 53
3. Extensão do fornecimento	página 53
3.1 Instruções de montagem: Base de 5 tubos	página 54
3.2 Instruções de montagem: Fixação na mesa	página 55
3.3 Instruções de montagem: Fixação na parede	página 56
3.4 Substituição do iluminante	página 57
4. Limpeza	página 57
4.1 Suporte	página 57
4.2 Corpo luminoso	página 57
4.3 Foco de exame	página 57
5. Características técnicas	página 57
6. Manutenção	página 57
6.1 Trabalhos de manutenção regulares	página 57
7. Indicações relativas à instalação elétrica	página 58
7.1 Condições do ambiente	página 58
7.2 Indicações importantes	página 58
8. UDI-DI básico	página 58
9. Disposição final	página 58
10. Tabelas: Indicações relativas à compatibilidade eletrónica	página 58
11. Garantia de qualidade	página 61

Caro consumidor! Agradecemos a sua escolha a favor do produto KaWe. Nossos produtos são de alta qualidade e durabilidade. As luminárias cumprem as disposições da Diretiva (UE) 2017/745 (Diretiva Europeia de Dispositivos Médicos) e, de acordo com esta Diretiva, pertencem à classe I de produtos médicos.

Antes de utilizar este produto, leia todo este manual de operação com o maior cuidado e observe as indicações relativas à manutenção.

As vantagens da tecnologia LED: Cores de luz variáveis, uma vida útil de pelo menos 50.000 horas, um alto nível de luminosidade e uma produção de calor quase não perceptível, tanto na área da cabeça do cirurgião como na própria área do ferimento. Mantiveram-se as vantagens da luminotecnica com focos halógenos aplicada pela KaWe: Reprodução natural das cores, iluminação exata da área do ferimento e posicionamento simples do corpo luminoso.

1. CONSELHOS DE SEGURANÇA

É indispensável observar o manual de operação quando desejar manusear o foco cirúrgico.

ATENÇÃO: Este aparelho não foi concebido para aplicação em áreas apresentando risco de explosão.

Favor de ler atentamente o manual de instruções para então poder apreciar todas as vantagens que o seu sistema de iluminação lhe apresenta e para evitar quaisquer danos possíveis no aparelho.

A manutenção corretiva do foco e, particularmente, os trabalhos de montagem só poderão ser realizados por pessoal com formação especializada.

O fabricante só responde pela segurança do foco cirúrgico se os trabalhos de reparação e as alterações tiverem sido efetuados por si próprio ou por um posto autorizado capaz de garantir o respeito das regras de segurança.

ATENÇÃO: Não se admite qualquer tipo de alterações no foco!

O fabricante não responde por danos corporais e materiais no caso de o foco cirúrgico tiver sido usado com outra finalidade ou operado erradamente ou aplicado com outra finalidade. O foco KaWe MASTERLIGHT HL / LED não é combinável com outros aparelhos.



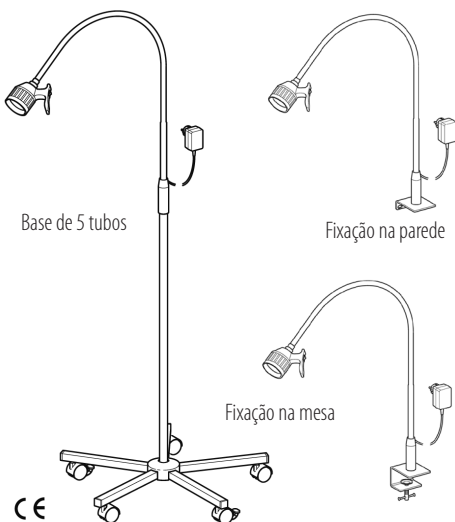











Antes de cada aplicação, certifique-se que o foco cirúrgico se encontra em estado impecável.



Indicações gerais

- Todos os focos cirúrgicos com suporte da KaWe são fornecidos com todos os componentes necessários para a sua montagem e conexão.
- A montagem é sobre um tripé, sobre a parede ou sobre uma mesa.
- Devido à embalagem, a base do suporte com os 5 rodízios é fornecida completamente desmontada. O tubo do suporte é sempre montado como unidade e só precisa de ser encaixado na base do suporte e fixado com o seu parafuso de fixação inferior.
- O foco cirúrgico é fornecido com cabo de conexão e conector de ligação à terra integrados.
- A tomada a ser utilizada deverá ter sido montada de acordo com as exigências de IEC resp. VDE 0100-710

Descrição dos símbolos:

	Fabricante
	Data de fabricação
	Número de lote
	Por favor, segue as instruções de uso
	Atenção! Ao proceder à montagem e substituição das ampolas
	Limite de temperatura
	Recolha separada de aparelhos elétricos e eletrônicos
	Conformidade com as Diretivas da UE pertinentes
	Produto médico
	Certificação GOST-R de mercadorias exportadas para a Rússia
	Restrição da umidade do ar
	Classe de proteção II
	Produto frágil
	Proteger contra umidade
	Advertência contra campo eletromagnético

► 2. DESCRIÇÃO RESUMIDA DO FOCO CIRÚRGICO KaWe MASTERLIGHT HL / LED

Finalidade:

As luminárias são projetadas para auxiliar no tratamento e diagnóstico em um ambiente hospitalar ou de consultório médico. Elas iluminam a área de trabalho e o corpo do paciente com luz „fria“ sem sombra de alta potência.

Aplicação:

Este produto só deve ser utilizado por pessoal treinado autorizado!

Grupo de pacientes para uso:

Todos os grupos de pacientes

► 3. EXTENSÃO DO FORNECIMENTO

- 1 Bloco de montagem, suporte
- 2 Tubos do tripé com rodízios com travão
- 3 Tubos do tripé com rodízios sem travão
- 1 Tubo do suporte
- 1 Tampa do suporte de tripé
- 1 Parafuso com cabeça cilíndrica M8 com disco
- 1 Chave fixa
- Corpo luminoso com braço
- Manual de operação

Instruções para o usuário e para o paciente:

Todos os incidentes graves envolvendo o produto devem ser relatados imediatamente ao fabricante e às autoridades competentes do Estado-membro relevante no qual o usuário e/ou paciente está localizado.

3.1 Instruções de montagem: Base de 5 tubos

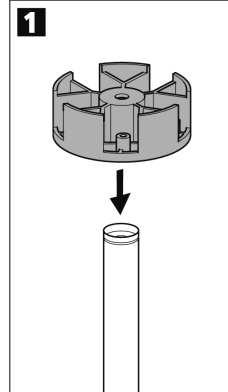
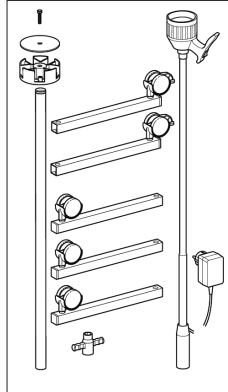
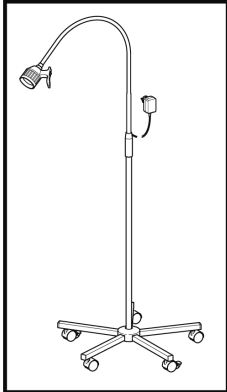

Peças de montagem

1. Encaixar bloco.

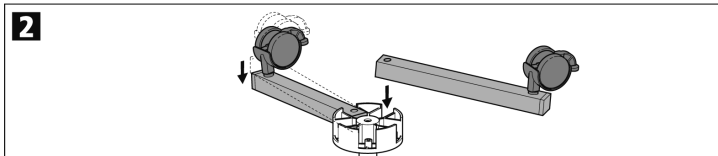

2. Encaixar os dois tubos da base da estrutura com rodízios com travão, um oposto ao outro.

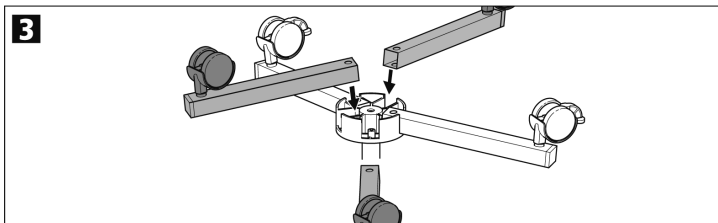

3. Encaixar os três tubos da base da estrutura com rodízios sem travão.

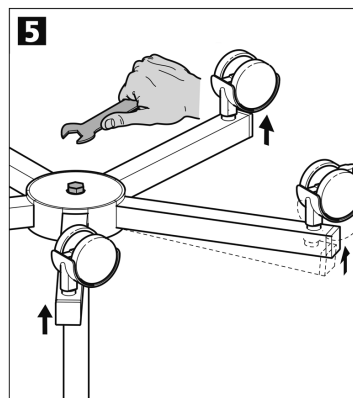
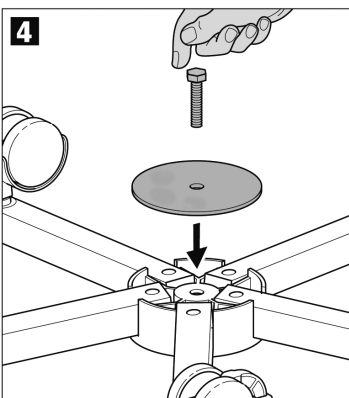

4. Encaixar o parafuso de sextavado.

5. Apertar o parafuso de sextavado.

pt

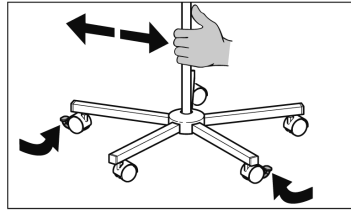
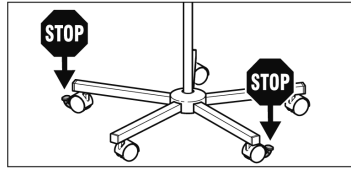
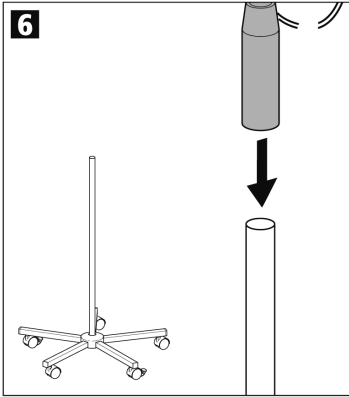

6. Encaixar a parte superior do foco de exame sobre a base da estrutura.

Travar os rodízios com travão. Para fazer avançar, destravar os rodízios com travão.

3.2 Instruções de montagem: Fixação na mesa

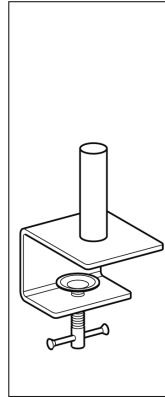
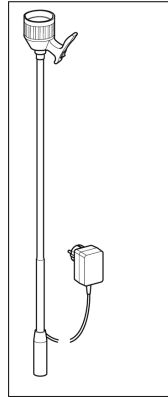
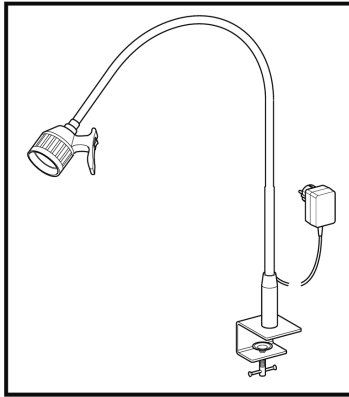

Peças de montagem

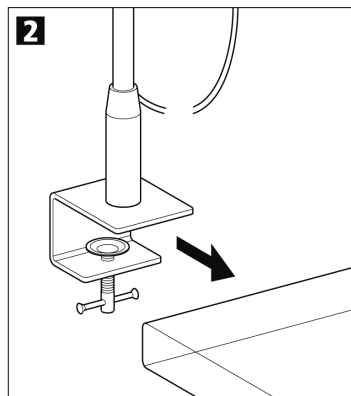
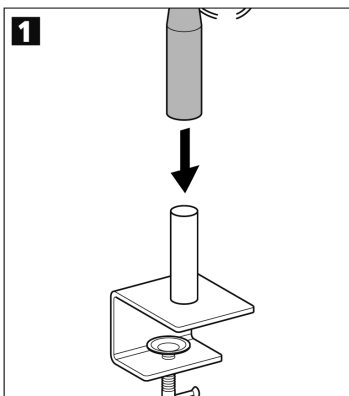

1. Encaixar a parte superior do foco de exame no grampo para fixação na mesa.

2. Fixar o foco de exame ao tampo de mesa.

3.3 Instruções de montagem: Fixação na parede

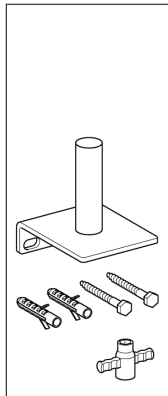
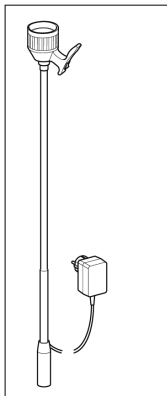
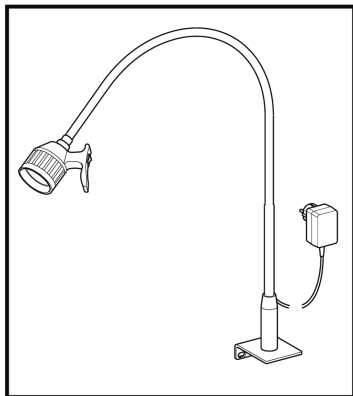

Peças de montagem

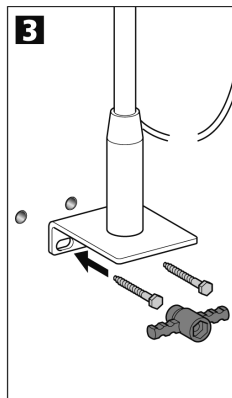
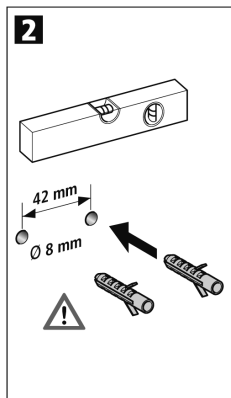
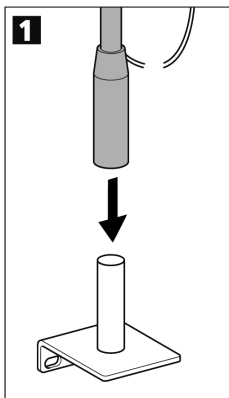

1. Encaixar a parte superior do foco de exame no suporte angular de parede.



2. Atenção, quando furar a parede! Verificar a parede quanto ao sistema de adução de corrente, gás e água.

3. Fixar o foco de exame à parede.

pt

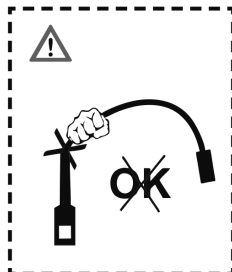
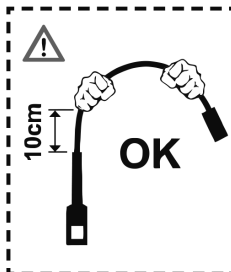
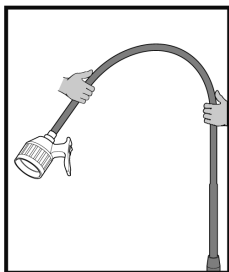

Só ajustar a direção da luz com ambas as mãos.

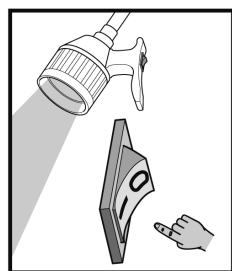
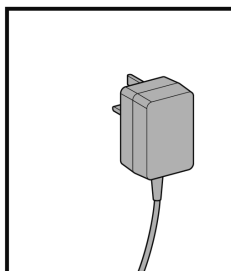
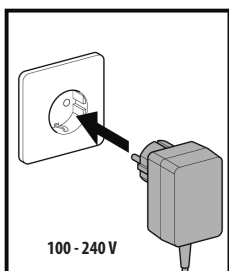

Alimentação elétrica (UE / GB)

LIGAR - I -
DES-LIGAR - 0 -

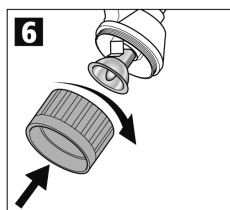
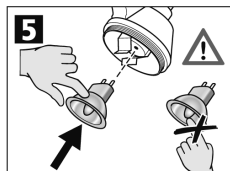
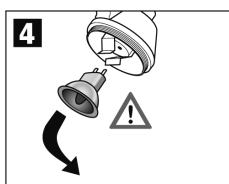
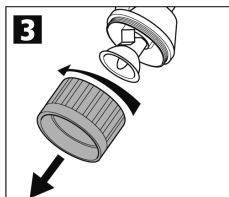
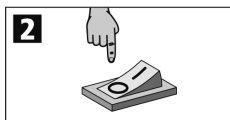
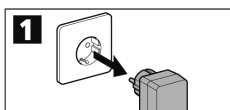

3.4 Substituição do iluminante

1. Separar da fonte de alimentação.
2. Colocar o interruptor em - 0 -.
3. Desaparafusar o anel.



4. Retirar a ampola defeituosa só depois de arrefecida.
5. Encaixar a ampola nova.
6. Aparafusar o anel.

► 4. LIMPEZA

Antes de proceder à limpeza, favor de desligar o foco. Retirar a ficha da tomada e deixar arrefecer a cabeça do foco.

4.1 Suporte: A superfície do suporte poderá ser mantida limpa, simplesmente limpando-a com um pano húmido. Para tal, poderá aplicar os agentes de limpeza comuns no mercado. Se desejar proceder a uma desinfeção, recomendamos agentes diluídos em água ou em álcool com um teor de no **máx. 20%**.

4.2 Corpo luminoso: O foco está dotado de uma superfície de alta qualidade. A superfície do foco facilmente poderá ser limpo com um pano húmido, aplicando um agente de limpeza comum no mercado. Se desejar proceder a uma desinfeção, favor de aplicar exclusivamente agentes de desinfeção à base de álcool com um teor **inferior a 20%**.

4.3 Foco de exame: **1.** O foco de exame é resistente a desinfetantes, ao desgaste, a urina e sangue. **2.** O foco de exame deverá ser limpo com um pano húmido e um desinfetante de superfície. **3.** Favor de limpar rodízios sujos, para evitar carga estática. **4.** Não aplicar agentes ácidos.

► 5. CARACTERÍSTICAS TÉCNICAS:

Altura máxima: aprox. 211 cm
Parte superior, área flexível: aprox. 82 cm
Diâmetro da base da estrutura: aprox. 70 cm
Peso: aprox. 4,7 kg
Tensão de alimentação: 100 - 240 Volt
Halogéneo: 12V / 35W / no máx. 5 A.
Vida útil da ampola halógena: ≥ 1.000 h
LED: 12V / 6,5W / 0,8 A max.
Vida útil da ampola de LED: aprox. 50.000h
Ângulo de radiação HL / LED: 8° / 24°
Temperatura de cor aprox. : HL: 3200K/LED: 4000K
Intensidade luminosa (HL), distância de 30 cm 44.000 Lux

Intensidade luminosa (LED), distância de 30 cm 31.000 Lux
Tamanho do campo luminoso
(no caso de uma distância de trabalho de 0,5m) 100 mm

Observações: As características técnicas estão sujeitas a determinadas variações, especialmente em relação à vida útil, temperatura de cor e a intensidade luminosa. O modelo de suporte deverá ser posicionado sobre superfícies planas.

Chamada de nota: O foco de exame não está protegido contra água! É indispensável observar as exigências dos grémios nacionais (normas e diretivas) para higiene e desinfeção.

► 6. MANUTENÇÃO

Após longos períodos de utilização, torna-se necessário reapertar os parafusos do foco KaWe MASTERLIGHT HL / LED. O foco cirúrgico deverá ser submetido a uma manutenção e inspeção, o mais tardar, de dois em dois anos.

Chamada de nota: Durante a sua utilização, o foco halogéneo poderá aquecer-se! Sempre que proceder a trabalhos de manutenção e inspeção, desligar o foco de exame e separar a fonte de alimentação da corrente. Proteger o foco exame contra ligamento involuntário.

6.1 Trabalhos de manutenção regulares: De dois em dois anos, o sistema de suporte do foco deverá ser submetido aos seguintes trabalhos de inspeção / manutenção: **1.** Fissuras nos elementos em material sintético **2.** Ensaio funcional **3.** Verificação da segurança elétrica **4.** Inspeção do sistema de suporte.

► 7. INDICAÇÕES RELATIVAS À INSTALAÇÃO ELÉTRICA

Por padrão, o foco KaWe MASTERLIGHT HL / LED é fornecido com um transformador. **Atenção! O transformador é um aparelho que pertence à classe de proteção II.**

7.1 Condições do ambiente

	Em serviço	
	Mín.	Mín.
Temperatura	+10° C	+40° C*
Humidade atmosférica relativa	30 %	75 %
Pressão atmosférica	700 hPa	1060 hPa

*no caso de temperaturas superiores ao descrito, favor de nos consultar

	Transporte/Armazenamento	
	Mín.	Mín.
Temperatura	-10° C	+50° C
Humidade atmosférica relativa	30 %	75 %
Pressão atmosférica	700 hPa	1060 hPa

7.2 Indicações importantes

No caso de operar vários focos ao mesmo tempo, é possível que a intensidade da irradiação total exceda o valor de 1000 W/m² devido a uma sobreposição dos vários campos de iluminação. Deste modo existe o risco de um nível alto de produção de calor no campo de iluminação. Devido à sobreposição dos campos de iluminação de vários focos, os valores de radiação podem exceder os valores limite para a radiação UV (< 400 nm) de 10 W/m². No caso de conectar mais lâmpadas ou aparelhos juntamente com o presente foco, aplica-se a seção 16 da norma EN 60601-A1:2012 e deverá-se, portanto, verificar eventualmente o cumprimento das respetivas exigências. Os focos de exame da KaWe estão sujeitos a medidas de precaução especiais relativas à CEM. As funções do foco de exame da KaWe podem ser afetadas por dispositivos de comunicação de alta frequência portáteis e móveis. (Favor de observar as seguintes tabelas)

► 8. UDI-DI BÁSICO

4030155KaWe10SK

► 9. DISPOSIÇÃO FINAL



Quando chegar ao final da vida útil do produto, os componentes do foco deverão ser entregues para disposição final conforme as respetivas leis em vigor. Tomar particular atenção a uma separação cuidadosa de materiais. Os circuitos impressos elétricos deverão ser entregues a um respetivo posto de reciclagem. O invólucro do foco cirúrgico e os componentes restantes do foco cirúrgico deverão ser entregues para disposição final separado por materiais.



► 10. TABELAS

Os focos de exame da KaWe estão sujeitos a medidas de precaução especiais quanto à CEM e deverão ser montados e instalados de acordo com as especificações relativas à CEM contidas nos papéis anexos. O funcionamento do foco de exame da KaWe pode ser afetado por equipamento de comunicação de RF portátil e móvel.

Orientações e declaração do fabricante – emissões eletromagnéticas

A estação KaWe MASTERLIGHT HL / LED destina-se a ser utilizada no ambiente eletromagnético especificado a seguir. O cliente ou utilizador do aparelho deverá garantir a aplicação em tal ambiente.

Testes de emissões	Conformidade	Ambiente eletromagnético – orientações
Emissões RF de acordo com CISPR 11	Grupo 1	KaWe MASTERLIGHT HL / LED utiliza energia RF apenas para o seu funcionamento interno. Por isso, as suas emissões de RF são muito baixas e é improvável que causem interferências em equipamento eletrónico próximo.
Emissões RF de acordo com CISPR 11	Classe B	A estação KaWe MASTERLIGHT HL / LED é adequada para ser utilizada em todos os estabelecimentos, incluindo estabelecimentos domésticos e aqueles diretamente ligados à REDE PÚBLICA de abastecimento de corrente de baixa tensão que abastece edifícios para fins domésticos.
Emissões harmónicas de acordo com IEC 61000-3-2	Classe A	
Flutuações de tensão/Emissões de flicker de acordo com IEC 61000-3-3	Conforme	

Orientações e declaração do fabricante – Imunidade eletromagnética

O foco KaWe MASTERLIGHT HL / LED foi concebido para operação em ambiente eletromagnético tal como descrito abaixo.
O cliente ou utilizador do foco KaWe MASTERLIGHT HL / LED deverá garantir a aplicação em tal ambiente.

Teste de imunidade	Nível de teste IEC 60601	Nível de conformidade	Ambiente eletromagnético – Orientações
Descarga eletro-estática (ESD) de acordo com IEC 61000-4-2	± 6 kV com contacto ± 8 kV sem contacto	± 6 kV com contacto ± 8 kV sem contacto	Os pavimentos dos corredores devem ser em madeira, cimento ou cerâmicos. Se os pavimentos estiverem revestidos com materiais sintéticos, a humidade relativa deve ser superior a 30%.
Corrente elétrica transitória rápida/em Burst de acordo com IEC 61000-4-4	± 2 kV para circuitos de alimentação elétrica ± 1 kV para circuitos de entrada e saída => não aplicável	± 2 kV para circuitos de alimentação elétrica ± 1 kV para circuitos de entrada e saída => não aplicável	A qualidade da corrente elétrica deve ser equivalente à de um ambiente hospitalar ou comercial típico.
Impulsos de tensão (Surges) de acordo com IEC 61000-4-5	± 1 kV tensão simétrica ± 2 kV tensão de modo comum	± 1 kV tensão simétrica ± 2 kV tensão de modo comum	A qualidade da corrente elétrica deve ser equivalente à de um ambiente hospitalar ou comercial típico.
Quebras de tensão, interrupções breves e flutuações da tensão de alimentação de acordo com IEC 61000-4-11	< 5 % UT (>95 % quebra de UT) para ½ ciclo 40 % UT (60 % quebra de UT) para 5 ciclos 70 % UT (30 % quebra de UT) para 25 ciclos < 5 % UT (>95 % quebra de UT) durante 5 segundos	< 5 % UT (>95 % quebra de UT) para ½ ciclo 40 % UT (60 % quebra de UT) para 5 ciclos 70 % UT (30 % quebra de UT) para 25 ciclos < 5 % UT (>95 % quebra de UT) durante 5 segundos	A qualidade da corrente elétrica deve ser equivalente à de um ambiente hospitalar ou comercial típico. Se o utilizador do foco KaWe MASTERLIGHT HL / LED necessitar de um funcionamento contínuo durante cortes no abastecimento da rede pública, recomenda-se que o foco KaWe MASTERLIGHT HL / LED seja alimentado através de um sistema de alimentação ininterrupta ou de uma pilha.
Campo magnético durante uma frequência de corrente (50/60 Hz) de acordo com IEC 61000-4-8	3 A/m	30 A/m	Os campos magnéticos da frequência de corrente devem situar-se em níveis característicos de um local típico em ambiente comercial ou hospitalar típico.

Nota: UT é a tensão de rede antes da aplicação do nível de teste.

Orientações e declaração do fabricante – Imunidade eletromagnética

O foco KaWe MASTERLIGHT HL / LED foi concebido para operação em ambiente eletromagnético tal como descrito abaixo. O cliente ou utilizador do foco KaWe MASTERLIGHT HL / LED deverá garantir a aplicação em tal ambiente.

Teste de imunidade	Nível de teste IEC 60601	Nível de conformidade	Ambiente eletromagnético – Orientações
Perturbações RF conduzidas de acordo com IEC 61000-4-6	3V 150 kHz a 80 MHz	3V	Qualquer equipamento de comunicações de RF portátil e móvel não deve ser utilizado mais perto de qualquer parte do foco KaWe MASTERLIGHT HL / LED, incluindo cabos, do que a distância de separação recomendada é calculada a partir da equação aplicável à frequência do transmissor. Distância de separação recomendada: $d = 1,12\sqrt{P}$ $d = 1,2\sqrt{P}$ para 80 MHz a 800 MHz $d = 2,3\sqrt{P}$ para 800 MHz a 2,5 GHz
Perturbações RF irradiadas de acordo com IEC 61000-4-3	3V/m 80 MHz bis 2,5 GHz	3V/m	em que P é a classificação máxima da potência nominal do transmissor em watts (W), de acordo com o fabricante do transmissor, e d é a distância de separação recomendada em metros (m). A força de campo de transmissores de RF fixos, como determinado por uma pesquisa no local eletromagnético ^a , deve ser inferior ao nível de cumprimento em cada amplitude da frequência ^b .  Poderá ocorrer interferência na proximidade de equipamento portador do seguinte símbolo.

Nota 1: A 80 e 800 MHz, é aplicável o valor de frequência mais elevado.

Nota 2: Estas diretrizes poderão não se aplicar em todas as situações. A propagação eletromagnética é afetada pela absorção e reflexão a partir de estruturas, objetos e pessoas.

a: Não é possível prever teoricamente com precisão a intensidade de campos criados por transmissores fixos, tais como bases para telefones de radiofrequência, serviços de rádio móveis terrestres, rádios amadores, emissões de rádio AM e FM, assim como emissões de TV. Para avaliar o ambiente eletromagnético por causa de transmissores de RF fixos, deverá ser considerado um levantamento do local eletromagnético. Se a força do campo medida no local de utilização do foco KaWe MASTERLIGHT HL / LED ultrapassar o nível de conformidade de RF indicado acima, o foco KaWe MASTERLIGHT HL / LED deverá ser observado para verificar o respetivo funcionamento normal. Caso seja observado um funcionamento anómalo, podem ser necessárias medidas adicionais, tais como a reorientação ou reposicionamento do foco KaWe MASTERLIGHT HL / LED.

b: Para além do intervalo de frequência de 150 kHz a 80 MHz, as forças do campo devem ser inferiores a 3V/m sein.

Distâncias de separação recomendadas entre equipamentos de comunicações de RF portáteis e móveis e do foco KaWe MASTERLIGHT HL / LED

O foco KaWe MASTERLIGHT HL / LED destina-se a ser utilizado em tal ambiente eletromagnético, no qual as perturbações RF são controladas. O cliente ou utilizador do foco KaWe MASTERLIGHT HL / LED pode ajudar a prevenir a interferência eletromagnética mantendo uma distância mínima entre o equipamento de comunicações por frequências rádio portátil e móvel (transmissores) e o foco KaWe MASTERLIGHT HL / LED – tal como recomendado a seguir, de acordo com a potência de saída máxima do equipamento de comunicação.

Potência nominal do transmissor (W)	Distância de separação de acordo com a frequência do transmissor (m)		
	150 kHz a 80 MHz $d = 1,2\sqrt{P}$	80 MHz a 800 MHz $d = 1,2\sqrt{P}$	800 MHz a 2,5 GHz $d = 2,3\sqrt{P}$
0,01	0,12	0,12	0,23
0,1	0,38	0,38	0,73
1	1,20	1,20	2,30
10	3,80	3,80	7,30
100	12,00	12,00	23,00

Para transmissores com uma potência nominal não indicada na lista acima, a distância de separação recomendada poderá ser estimada utilizando a equação aplicável à frequência do transmissor, em que P é a potência nominal do transmissor em watts (W) de acordo com as indicações do fabricante do mesmo.

Nota 1: A 80 e 800 MHz, é aplicável o valor de frequência mais elevado.

Nota 2: Estas diretrizes poderão não se aplicar em todas as situações. A propagação eletromagnética é afetada pela absorção e reflexão a partir de estruturas, objetos e pessoas.



► 11. GARANTIA DE QUALIDADE

Quando operado devidamente e respeitando o nosso manual de operação, este produto dispõe de uma garantia de qualidade com a duração de dois anos a partir da data de venda (exceto ampolas/pilhas recarregáveis). No caso de surgirem quaisquer dúvidas ou se tiverem que ser realizados eventuais trabalhos de reparação, favor de consultar o seu distribuidor autorizado.

Оглавление

1. Требования техники безопасности	стр. 62
2. Краткое описание светильника KaWe MASTERLIGHT Галоген / LED	стр. 63
3. Объем поставки	стр. 63
3.1 Руководство по сборке: штатив с 5-ти ножной крестовиной	стр. 64
3.2 Руководство по сборке: крепление к столу	стр. 65
3.3 Руководство по сборке: крепление к стене	стр. 66
3.4 Замена источника света	стр. 67
4. Чистка	стр. 67
4.1 Штатив	стр. 67
4.2 Корпус светильника	стр. 67
4.3 Светильник смотровой	стр. 67
5. Технические данные	стр. 67
6. Техническое обслуживание	стр. 67
6.1 Регулярное техобслуживание	стр. 67
7. Указания по установке электроприборов	стр. 68
7.1 Условия окружающей среды	стр. 68
7.2 Важные указания	стр. 68
8. Базовый UDI-DI	стр. 68
9. Утилизация	стр. 68
10. Таблицы электромагнитной совместимости	стр. 68
11. Гарантия	стр. 71

Уважаемый покупатель, спасибо, что выбрали продукт KaWe. Наши продукты отличаются высоким качеством и долговечностью. Светильники соответствуют положениям Директивы (ЕС) 2017/745 (Европейская директива по медицинским приборам) и согласно этой директиве относятся к I классу медицинской продукции.

Перед началом пользования следует полностью и внимательно прочитать настоящее руководство по применению и соблюдать указания по уходу.

Преимущества LED техники: срок службы не менее 50.000 часов, высокая яркость, минимальное тепловыделение как в области головы хирурга, так и в оперируемой области. Сохранены преимущества прежней технологии с применением галогеновых ламп – естественная цветопередача, точное освещение области раны и легкое позиционирование корпуса лампы.

► 1.ТРЕБОВАНИЯ ТЕХНИКИ БЕЗОПАСНОСТИ

При использовании светильником следите за соблюдением руководства по эксплуатации.

Внимание! Данный прибор не предназначен для эксплуатации во взрывоопасных зонах.

Ознакомление с инструкцией по эксплуатации поможет вам использовать все преимущества системы освещения и избежать возможных повреждений.

Сборка и ввод светильника в эксплуатацию разрешается только специально обученному персоналу.

Производитель несет ответственность за надежность светильника только при условии, если ремонт и изменения в конструкции произведены им самим или уполномоченным лицом с гарантией соблюдения правил безопасности.

Внимание! Запрещается производить какие-либо изменения в конструкции светильника!

Производитель не несет ответственности за персональный или материальный ущерб, если светильник применялся не по назначению или неправильно обслуживался. Светильник KaWe MASTERLIGHT Галоген / LED не комбинируется с другими приборами.

Перед каждым применением проверяйте светильник на предмет повреждений.

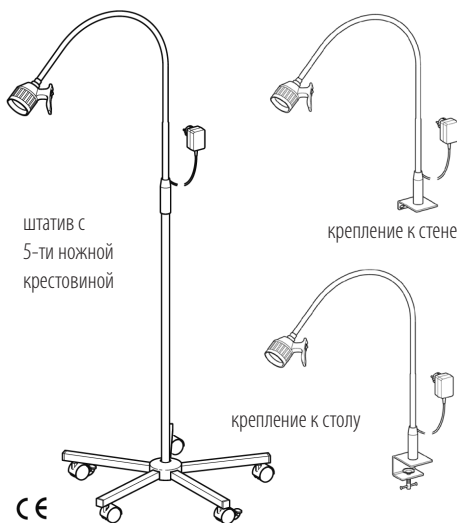

Общие указания

- Все KaWe-светильники на штативе поставляются со всеми необходимыми частями для сборки и подключения.
- Крепление осуществляется на штативе, на стене или на столе.
- В целях удобства транспортировки 5-ти ножная крестовина поставляется в разобранном виде. Труба штатива смонтирована в один блок и должна быть лишь соединена с основанием с помощью крепежного винта.
- Светильник поставляется с интегрированным соединительным кабелем и штекером с защитным контактом.
- Используемая штепсельная розетка должна соответствовать требованиям международной комиссии по электротехнике (IEC) или Союза немецких электротехников (VDE 0100-710).

Значение символов:

	Производитель
	Дата выпуска
	Партия товара
	Пожалуйста, соблюдайте руководство по применению
	Внимание! При сборке и замене лампочки
	Температурные ограничения
	Дифференцированный сбор электрических и электронных приборов
	Соответствие изделия ЕС требованиям
	Медицинское изделие
	ГОСТ-R сертификация экспортных товаров, ввозимых в Россию
	Ограничение влажности воздуха
	Класс защиты II
	Хрупкое изделие
	Беречь от влаги
	Внимание. Электромагнитное поле

► 2. КРАТКОЕ ОПИСАНИЕ СВЕТИЛЬНИКА KaWe MASTERLIGHT Галоген / LED

Назначение:

Светильники предназначены для помощи при лечении и диагностике в условиях больницы или медицинского кабинета. Они освещают рабочую зону и тело пациента бестеневым холодным светом высокой мощности.

Применение:

Это изделие должно использоваться только авторизованным обученным персоналом!

Группа пациентов, которой показано применение:

Все группы пациентов.

► 3. ОБЪЁМ ПОСТАВКИ

- 1 х монтажный блок штатива
- 2 х трубки крестовины с тормозными роликами
- 3 х трубки крестовины без тормозных роликов
- 1 х трубка штатива
- 1 х заглушка для штатива
- 1 х винт с цилиндрической головкой M8 с шайбой
- 1 х гаечный ключ
- 1 х корпус светильника с кронштейном
- Руководство по применению

Указание для пользователя и пациента:

Обо всех серьезных происшествиях, связанных с изделием, следует незамедлительно сообщить производителю и компетентным органам соответствующего государства-участника, в котором находится пользователь и/или пациент.



3.1 Руководство по сборке: штатив с 5-ти ножной крестовиной

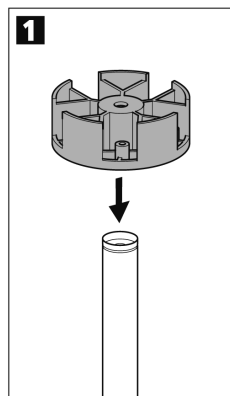
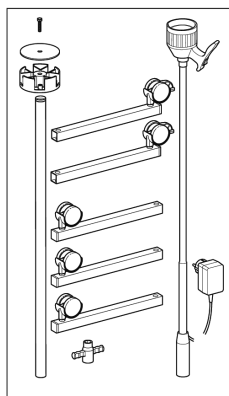
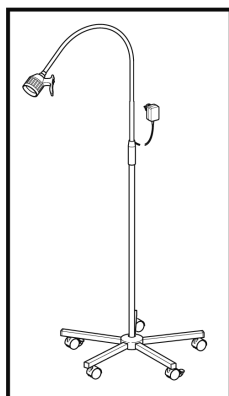

Комплектующие

1. Насадите блок.

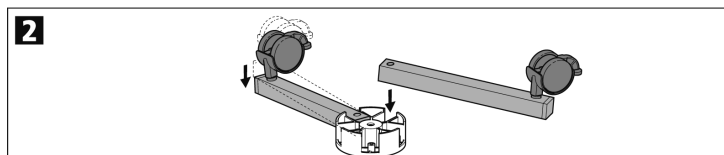

2. Навесьте две прямоугольные трубки с блокировочными роликами друг против друга.

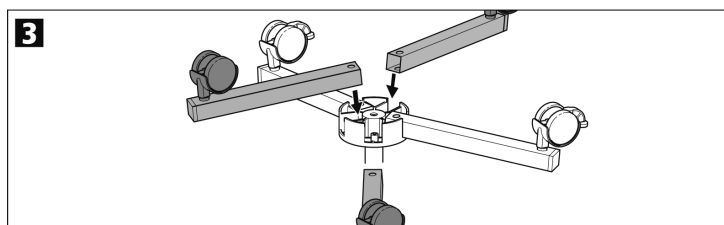

3. Навесьте три прямоугольные трубки без тормозных роликов.

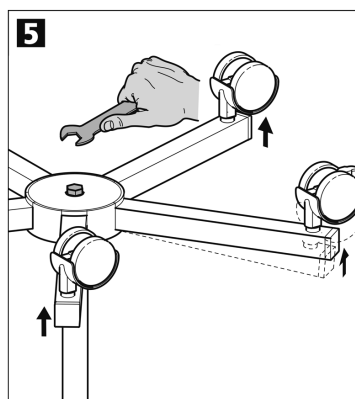
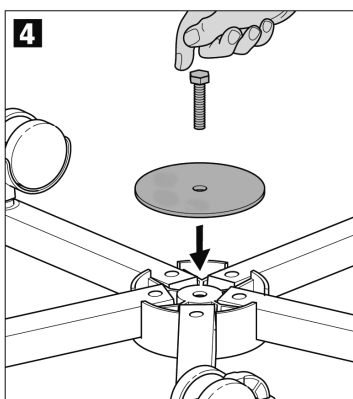

4. Вкрутите винт с шестигранной головкой.

5. Закрепите винт с шестигранной головкой.

ru

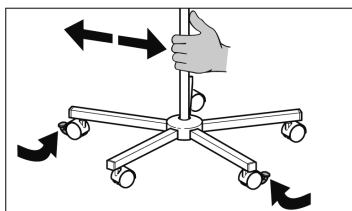
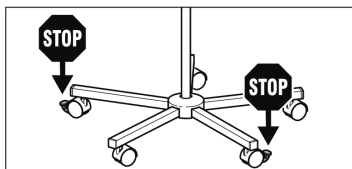
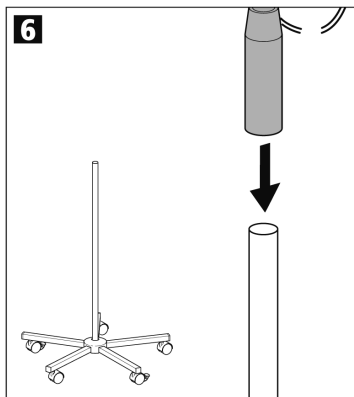

6. Насадите верхнюю часть светильника на штатив.

Зафиксируйте блокировочные ролики. Для поступательного движения блокировочные ролики освободите от стопора.

3.2 Руководство по сборке: крепление к столу

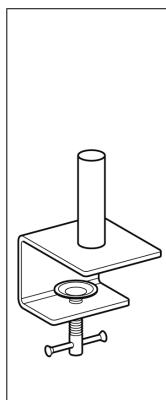
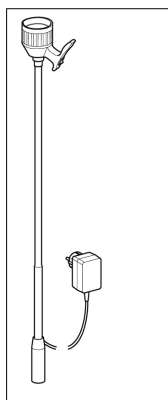
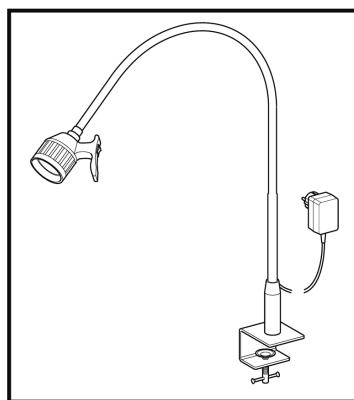

Комплектующие

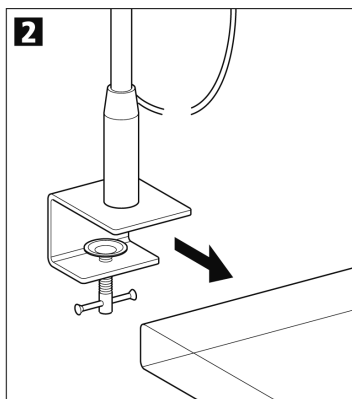
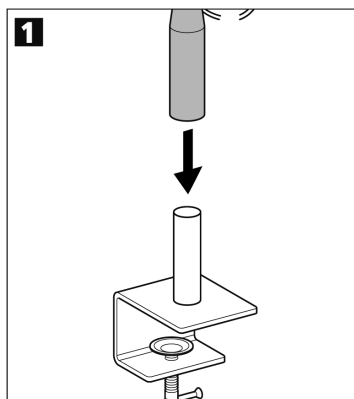

1. Насадите верхнюю часть светильника на настольное крепление.

2. Привинтите светильник к столешнице.

3.3 Руководство по сборке: крепление к стене

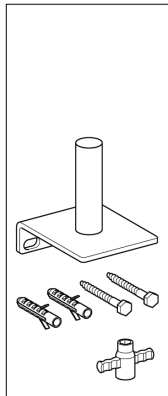
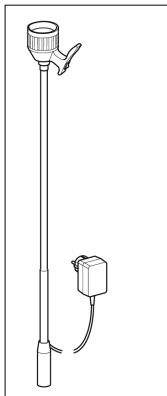
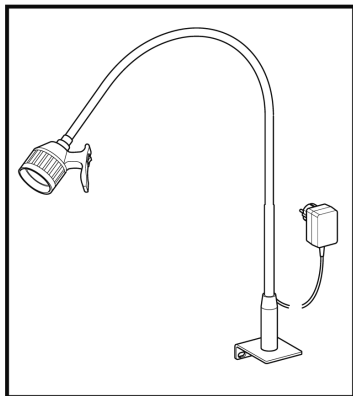

Комплекующие

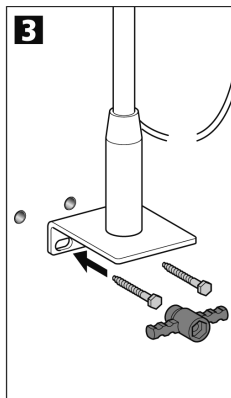
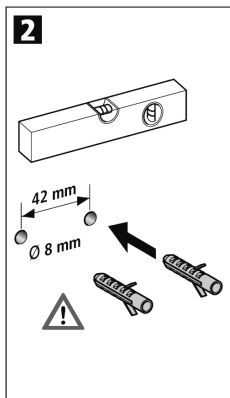
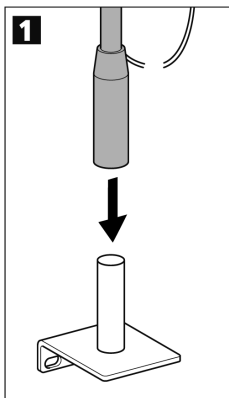

1. Насадите верхнюю часть светильника на настенное крепление.



2. Осторожно при сверлении! Проверьте стену на электро-, газо- и водопроводы.

3. Привинтите светильник к стене.

ru

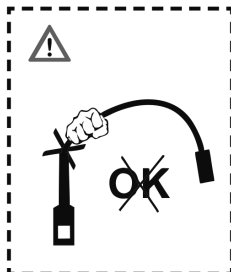
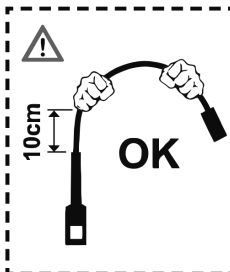
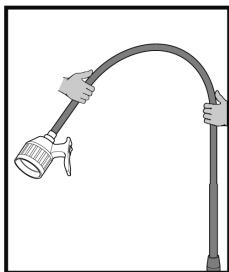

Направление света устанавливать двумя руками.

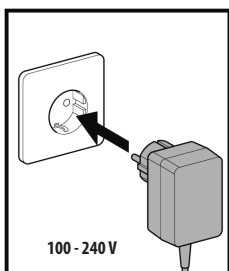

100 - 240 V

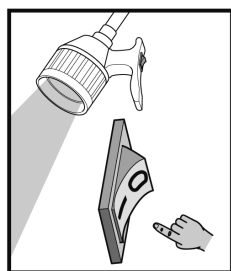
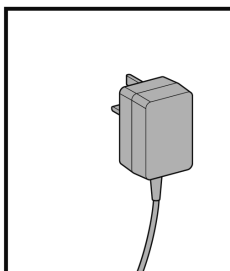

Подключение к сети (ЕС / ВБ)

Включено - I -
Выключено - 0 -

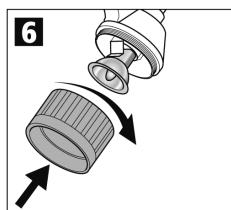
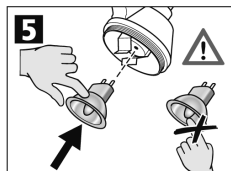
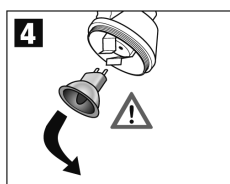
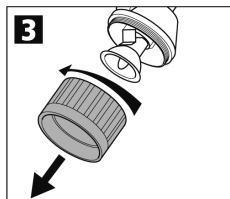
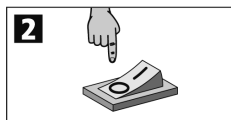
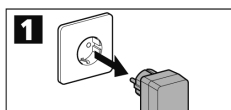
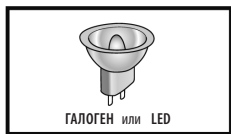

3.4 Замена источника света

1. Вытащите штекер из розетки.
2. Выключатель поставьте на - 0 -.
3. Отвинтите кольцо.



4. Выньте перегоревшую лампу накаливания только после охлаждения.
5. Вставьте новую лампочку.
6. Закрутите кольцо.

► 4. ЧИСТКА

Выключить светильник перед очисткой. Вытянуть штепсельную вилку и дать остынуть лампе.

4.1 Штатив: Поверхность штатива можно протирать влажной тканью с использованием обычных чистящих средств. Для дезинфекции рекомендуются средства, растворенные в воде или в мах. 20%-м растворе спирта.

4.2 Корпус светильника: поверхность светильника выполнена из высококачественного материала, которую можно протирать влажной тканью с использованием обычных чистящих средств. Запрещается использовать дезинфицирующие средства, уровень содержания спирта которых превышает 20%.

4.3 Светильник смотровой: 1. Светильник смотровой устойчив к воздействию дезинфицирующих средств, урины и крови, а так же к истиранию. 2. Светильник протирается влажной тканью и дезинфицирующим средством для поверхностей на спиртовой основе. 3. Загрязнённые ролики необходимо чистить во избежание накопления статического электричества. 4. Не использовать кислотосодержащие средства.

► 5. ТЕХНИЧЕСКИЕ ДАННЫЕ

Максимальная высота прил. 211 см
 Поворотный диапазон верхнего кронштейна прил. 82 см
 Диаметр 5-ти ножной крестовины прил. 70 см
 Вес прил. 4,7 кг
 Напряжение сети 100 – 240 В
 Галоген 12 В / 35Вт. / 5 А максимум
 Ресурс галогенной лампы ≥ 1.000 ч
 LED 12 В / 6,5 Вт. / 0,8 А максимум
 Ресурс LED-лампы прил. 50.000h
 Угол излучения галоген / LED 8° / 24°
 Цветовая температура (Кельвин) прил. HL: 3200° / LED: 4000°K

Интенсивность света (HL) на расстоянии 30 см 44.000 Лх
 Интенсивность света (LED) на расстоянии 30 см 31.000 Лх
 Размер светового пятна на расстоянии 0,5 м 100 мм

Примечание: допустимы отклонения технических характеристик. Особенно это касается срока службы, цветовой температуры и интенсивности света. Модель на штативе должна располагаться на ровной горизонтальной поверхности.

Указание: светильник смотровой не является водонепроницаемым! Соблюдайте требования национальных органов (Стандарты и Директивы) по вопросам гигиены и дезинфекции.

► 6. ТЕХНИЧЕСКОЕ ОБСЛУЖИВАНИЕ

После длительного пользования светильником KaWe MASTER-LIGHT Галоген / LED надлежит снова затянуть винты. Контроль и техническое обслуживание должны проводиться не реже 1-го раза в 2 года.

Внимание: при использовании галогенной лампы светильник может нагреваться! При проведении контроля и техобслуживания отключите светильник и вытяните штекер из розетки. Проследите за предотвращением возможного произвольного включения светильника.

6.1 Регулярное техническое обслуживание: Каждые 2 года несущая конструкция светильника подлежит контролю/техобслуживанию на: **1.** трещины на пластиковых деталях **2.** функциональную проверку **3.** электробезопасность **4.** проверку несущей конструкции.

7. УКАЗАНИЯ ПО ЭЛЕКТРОУСТАНОВКЕ

Светильник KaWe MASTERLIGHT Галоген / LED согласно стандарту поставляется с адаптером переменного тока.

Внимание! Источник питания относится к классу защиты II.

7.1 Условия окружающей среды

	Эксплуатация	
	Мин.	Макс.
Температура	+10°С	+40°С*
Относительная влажность воздуха	30 %	75 %
Давление воздуха	700 гПа	1060 гПа

*при более высоких температурах проконсультируйтесь с производителем

	Транспортировка/ Хранение	
	Мин.	Макс.
Температура	-10°С	+50°С
Относительная влажность воздуха	30 %	75 %
Давление воздуха	700 гПа	1060 гПа

7.2 Важные указания

В случае одновременной работы нескольких светильников возможно наложение световых полей, причем общая освещенность может превысить 1000 Вт/м², что приводит к риску повышенного теплообразования в области светового поля. Наложение световых полей также может стать причиной превышения нормы УФ-излучения (< 400 нм), равной 10 Вт/м². При подключении дополнительно нескольких светильников или приборов руководствуются разделом 16 единых норм EN 60601-А1:2012, чтобы убедиться в соблюдении всех требований. Смотровые светильники KaWe подлежат особым мерам безопасности в вопросе электромагнитной совместимости. На работу смотровых светильников KaWe могут влиять переносные и мобильные высокочастотные приборы (напр. мобильный телефон). См. далее таблицы.

8. БАЗОВЫЙ UDI-DI

4030155KaWe10SK

9. УТИЛИЗАЦИЯ



В конце жизненного цикла прибора все его части должны быть надлежащим образом утилизированы. Обращайте внимание на тщательное разделение материала. Электрические платы утилизировать с специализированных пунктах приема. Корпус лампы и остальные части светильника утилизируются в соответствии с материалом.

10. ТАБЛИЦЫ

Смотровые KaWe светильники нуждаются в специальных мерах предосторожности, связанных с электромагнитной совместимостью (ЭМС) технических средств и должны быть установлены в соответствии с сопроводительными документами, содержащими информацию об ЭМС. Портативные и мобильные высокочастотные приборы коммуникации могут ухудшить качество функционирования смотровых светильников KaWe.

Рекомендации и заявление изготовителя в отношении электромагнитного излучения.

KaWe MASTERLIGHT Галоген / LED предназначен для использования в электромагнитной среде, указанной ниже. Клиент или пользователь этого продукта должны обеспечить использование в таких условиях.

Измерения излучения	Соответствие	Электромагнитная среда – руководство
ВЧ излучения согласно CISPR 11	Группа 1	KaWe MASTERLIGHT Галоген / LED использует энергию высокой частоты исключительно для своей внутренней функции. Поэтому высокочастотные излучения являются незначительными и не создают помех, находящимся вблизи электронным приборам.
ВЧ излучения согласно CISPR 11	Класс В	KaWe MASTERLIGHT Галоген / LED предназначен для использования во всех помещениях, в том числе и жилых, которые непосредственно подключены к общественной сети электроснабжения.
Гармоническая составляющая по IEC 61000-3-2	Класс А	
Колебания напряжения / мерцание по IEC 61000-3-3	Выполнено	

Рекомендации и заявление изготовителя в отношении электромагнитной помехоустойчивости.

KaWe MASTERLIGHT Галоген / LED предназначен для использования в электромагнитной среде, указанной ниже.
Клиент или пользователь KaWe MASTERLIGHT Галоген / LED должны обеспечить использование в таких условиях.

Тест на помехоустойчивость	Проверочный уровень по IEC 60601	Уровень соответствия	Электромагнитная среда – руководство
Электростатический разряд (ESD) согласно нормам IEC 61000-4-2 (МЭК)	± 6 кВ Контакт (косвенный) ± 8 кВ Воздушная среда	± 6 кВ Контакт ± 8 кВ Воздушная среда	Покрывание полов должно быть из дерева, бетона или керамической плитки. Если пол покрыт синтетическим материалом, относительная влажность воздуха должна быть не менее 30%.
Наносекундные импульсные помехи/кратковременная неустойчивость в электропитании в соответствии с IEC 61000-4-4 (МЭК)	± 2 кВ для линии электроснабжения ± 1 кВ для линии ввода/вывода => не применимо	± 2 кВ для линии электроснабжения ± 1 кВ для линии ввода/вывода => не применимо	Качество напряжения питания должно соответствовать напряжению питания, характерного для учреждений и больниц.
Выброс тока и напряжения в соответствии с IEC 61000-4-5 (МЭК)	± 1 кВ Противофазное напряжение (симметричное) ± 2 кВ синфазный сигнал	± 1 кВ Противофазное напряжение (симметричное) ± 2 кВ синфазный сигнал	Качество напряжения питания должно соответствовать напряжению питания, характерного для учреждений и больниц.
Кратковременное понижение напряжения, перерыв и перепады в подаче электроснабжения и перепады напряжения на выходных линиях снабжения электроэнергией в соответствии с IEC 61000-4-11 (МЭК)	<5% UT (> 95% понижение в UT) на 0,5 цикла 40% UT (60% понижение в UT) на 5 циклов 70% UT (30% понижение в UT) на 25 циклов <5% UT (> 95% понижение в UT) на 5 сек	<5% UT (> 95% понижение в UT) на 0,5 цикла 40% UT (60% понижение в UT) на 5 циклов 70% UT (30% понижение в UT) на 25 циклов <5% UT (> 95% понижение в UT) на 5 сек	Качество напряжения питания должно соответствовать напряжению питания, характерного для учреждений и больниц. Если пользователю необходимо бесперерывное функционирование светильника KaWe MASTERLIGHT Галоген / LED, даже в случае сбоев в энергоснабжении, рекомендуется использование источника бесперебойного питания или батареек.
Магнитное поле с частотой питающей сети (50/60Гц) в соответствии с IEC 61000-4-8	3 А/м	30 А/м	Частота электромагнитного поля должна соответствовать нормам, характерным для учреждений и больниц.

Примечание: UT – это напряжение сети переменного тока до применения контрольного уровня.



Рекомендации и заявление изготовителя в отношении электромагнитной помехоустойчивости

KaWe MASTERLIGHT Галоген / LED предназначен для использования в электромагнитной среде, указанной ниже. Клиент или пользователь KaWe MASTERLIGHT Галоген / LED должны обеспечить использование в таких условиях.

Испытание на помехоустойчивость	Контрольный уровень по IEC 60601	Уровень со-ответствия	Рекомендации по электромагнитной среде
<p>Кондуктивные помехи, наведенные радиочастотными электромагнитными полями в соответствии IEC 61000-4-6 (МЭК)</p>	<p>3 В 150 КГц до 80 МГц</p>	<p>3 В</p>	<p>Портативное и передвижное оборудование РЧ связи не должно использоваться ближе к какой-либо детали KaWe MASTERLIGHT Галоген / LED, включая провода, чем рекомендованный пространственный разнос, рассчитанный по формуле, применяемой к частоте передатчика.</p> <p>Рекомендуемый пространственный разнос: $d = 1,2\sqrt{P}$ $d = 1,2\sqrt{P}$ для 80 МГц до 800 МГц $d = 2,3\sqrt{P}$ для 800 МГц до 2,5 ГГц</p> <p>где P является оценкой максимальной выходной мощности передатчика в ваттах (Вт) согласно изготовителю передатчиков, а d – это рекомендуемый пространственный разнос в метрах (м).</p>
<p>Излучаемые помехи, наведенные радиочастотными электромагнитными полями в соответствии IEC 61000-4-3 (МЭК)</p>	<p>3 В/м 80 МГц до 2,5 ГГц</p>	<p>3 В/м</p>	<p>Интенсивность поля от стационарных радиопередатчиков, установленная обследованием электромагнитного излучения места^а, должна быть меньше уровня соответствия требованиям в каждом частотном диапазоне^б.</p> <p>Помехи могут произойти вблизи оборудования, обозначенного следующим символом:</p> 

Примечание 1: При 80 МГц и 800 МГц применяется более высокий диапазон частот.

Примечание 2: Эти рекомендации могут быть применимы не во всех ситуациях. На распространение электромагнитного излучения влияет ее поглощение и отражение от построек, предметов и людей.

а) Интенсивность поля от стационарных РЧ-передатчиков, например, базовых станций для радио (сотовых или беспроводных) телефонов и наземных передвижных радиовещаний, любительских радио, AM- и ЧМ- радио- и телевещаний невозможно теоретически предсказать точно. Для оценки электромагнитной среды, вызванной стационарными РЧ- передатчиками, следует подумать о применении обследования места электромагнитного излучения. Если измеренная интенсивность поля в месте использования светильника KaWe MASTERLIGHT Галоген / LED превышает применимый уровень соответствия требованиям РЧ помехоустойчивости, приведенный выше, то следует понаблюдать за светильником, чтобы проверить его нормальную работу. Если проявится работа с отклонениями, могут понадобиться дополнительные меры, например, переориентация или перемещение светильника KaWe MASTERLIGHT Галоген / LED в другое место.

б) При диапазоне частот от 150 КГц до 80 МГц и более интенсивность поля должна быть менее чем 3 В/м.

Рекомендуемое расстояние между портативными и мобильными высокочастотными приборами коммуникации и светильником KaWe MASTERLIGHT Галоген / LED

Светильник KaWe MASTERLIGHT Галоген / LED предназначен для использования в электромагнитной среде, в которой излучаемые радиопомехи контролируются. Клиент или пользователь KaWe MASTERLIGHT Галоген / LED могут предотвратить электромагнитные помехи при соблюдении рекомендуемого расстояния между переносными и мобильными высокочастотными приборами коммуникации и KaWe MASTERLIGHT Галоген / LED – в зависимости от коммуникативного прибора, согласно ниже указанным данным.

Номинальная мощность передатчика в (Вт)	Пространственный разнос согласно частотности передатчика (м)		
	от 150 КГц до 80 МГц $d = 1,2\sqrt{P}$	от 80 МГц до 800 МГц $d = 1,2\sqrt{P}$	от 800 МГц до 2,5 ГГц $d = 2,3\sqrt{P}$
0,01	0,12	0,12	0,23
0,1	0,38	0,38	0,73
1	1,20	1,20	2,30
10	3,80	3,80	7,30
100	12,00	12,00	23,00

Для передатчиков, максимальная номинальная мощность которых не указана в вышеупомянутой таблице, рекомендуемое расстояние d можно рассчитать в метрах (м) с помощью формулы, применимой к частотности передатчика, в которой P – максимальная номинальная мощность передатчика в ваттах (Вт) согласно указаниям производителя передатчика.

Примечание 1: При 80 МГц и 800 МГц применим высокий диапазон частот.

Примечание 2: Данные рекомендации применимы не во всех ситуациях. На распространение электромагнитного излучения влияет его поглощение и отражение от построек, предметов и людей.

► 11. ГАРАНТИЯ

При правильном использовании и учете наших указаний мы предоставляем 2 года гарантии с даты продажи (гарантия не распространяется на лампы и аккумуляторы). Если у Вас возникнут вопросы или необходимость в ремонте, обращайтесь к своему продавцу в сети специализированной торговли.



kompetenz in medizintechnik
weltweit



- de** Alle Angaben ohne Gewähr – Änderungen vorbehalten.
- en** All information is without guarantee and subject to change.
- fr** Informations sous toutes réserves – Sous réserve de modifications.
- it** Tutte le informazioni sono fornite senza alcuna garanzia e possono essere modificate.
- es** Toda la información sin compromiso. Nos reservamos el derecho de realizar cambios.
- pt** Todas as indicações entendem-se sem compromisso – Sujeito a alterações sem aviso prévio.
- ru** Информация представлена без гарантий любого рода – оставляем за собой право вносить изменения.



KIRCHNER & WILHELM GmbH + Co. KG
Eberhardstr. 56 • 71679 Asperg • Germany

Zentrale / Central office

Fon: +49 -7141-68188-0

Fax: +49 -7141-68188-11

Email: info@kawemed.de

Internet: www.kawemed.com